

SKIPPER

2 Axis Electromagnetic Log

EML224

Operation and Installation Manual



SKIPPER Electronics AS
Enebakkveien 150
P. O. Box 151, Manglerud
0612 Oslo, Norway
www.skipper.no

Telephone: +47 23 30 22 70
Telefax: +47 23 30 22 71
E-mail: support@skipper.no
Co. reg. no: NO-965378847-MVA

Document number: DM-E001-SB Rev 1.27.19A
Edition 20100326 sw.1.27.19

Weitergabe sowie vervielfältigung dieser unterlage, verwertung und mitteilung ihres inhaltes nicht gestattet, soweit nicht ausdrücklich zugestanden. zuwiderhandlungen verpflichten zu schadenersatz.

Toute communication ou reproduction de ce document, toute exploitation ou communication de ou son contenu sont interdites, sauf autorisation expresse. Tout manquement à cette règle est illicite et expose son auteur au versement de dommages et intérêts.

Copying of this document, and giving it to others and the use or communication of contents thereof, are forbidden without express authority. Offenders are liable to the payment of damages.

Sin nuestra expresa autorización, queda terminantemente prohibida la reproducción total o parcial de este documento, así como su uso indebido y/o su exhibición o comunicación a terceros. De los infractores se exigirá el correspondiente resarcimiento de daños y perjuicios.

Contents

- 1. Introduction..... 6**
 - System Summary6
 - Sensor6
 - Operator Unit.....6
 - Data Entry..... 6
 - Fig. 1.1 System Overview..... 7
 - Interfacing8
 - Outputs..... 8
 - Inputs..... 8
 - Alarms 8
 - Fig. 1.2. Display unit panel layout..... 9
- 2. Operation..... 10**
 - Parameter entry 10
 - Fig. 2.1 Setting and Parameter Entry Flowchart 10
 - Operation Screens 11
 - Fig. 2.2. Schematic overview of screens and softkey menus11
 - Fig. 2.3. Screen A 12
 - Fig. 2.4. Screen B 13
 - Fig. 2.5 A. Screen Com, Menu 1 14
 - Fig. 2.5 B. Screen Com, Menu 1 Error/Warning messages 15
 - Fig. 2.6. Screen Com, Menu 2..... 16
 - Fig. 2.7. Screen Status, Menu 1 17
 - Fig. 2.8. Screen Status, Menu 2 18
 - Fig. 2.9 Screen Status, Menu 3 19
 - Fig. 2.10. Screen Status, Menu 4 20
 - Fig. 2.11. Screen Status, Menu 5 21
 - Fig. 2.12. Screen Status, Menu 6 22
 - Fig. 2.13. Screen Calibration, Menu 1 23
 - Fig. 2.14. Screen Calibration, Menu 2 24
 - Fig. 2.15. Screen Calibration, Menu 3 25
- Principal Functions..... 26**
 - Principles of Electromagnetic Log 26
 - Power ON/OFF 26
 - Fixed Key Functions 26
 - Screen Select 26
 - Backlight adjustment 26
 - Day/Night 26
 - Key Functions..... 27
 - Menu 27
 - Trip Reset 27
 - Alarm Settings 27
 - Clock and Calendar Settings 27
 - Simulator 27
 - Status Screen..... 27
 - Nonvolatile Parameter Memory..... 27
 - Options..... 27
 - Repeaters/speed and distance..... 27

3. User Maintenance	28
Sensor Maintenance.....	28
Operator Unit Maintenance.....	28
4. Installation.....	29
Standard System Supply	29
Hull Fitting	29
Sensor Location.....	29
Part Positioning and Welding	29
The Electronic Unit	30
Sensor/Electronic Unit interconnection	30
Transducer/Electronic Unit PCB	31
Fig. 4.2. Sensor /Electronic Unit, Wiring diagram.	31
Operator Unit Installation	32
Fig. 4.3. Voltage selection connectors and fuses, Terminal Board, EML224 Operator Unit.....	33
Fig. 4.4. Back-up Battery Jumper, I/O Board.....	34
Back-up Battery Jumper JP200	34
Fig. 4.5. Function LEDs, Terminal Board.	35
Interfacing.	36
Fig. 4.6. Input/Output Circuitry.....	36
Interfacing	37
Alarm Relay	37
Log Pulse Outputs	37
Analogue Interfaces.....	37
Fig. 4.7. Alarm interconnection	38
Fig. 4.8. Misc IO examples.....	39
NMEA interface	40
Options.....	40
Repeaters.....	40
5. Start-up and system adaption.....	41
Analogue Outputs and Log Pulse Outputs Range Selection.....	41
Language and Units of Measure.....	41
NMEA Setup.....	41
EML224 transmitted (originated) NMEA 0183 messages.....	42
6. Calibration procedure	43
Calibration routine:	44
Activation of the hidden menus	44
Step 1. Heading error correction:	45
Step 2a. Manual speed calibration/adjustment:.....	45
Step 2b. Semi Automatic calibration:	46
7. Specifications	48
Dimensions.....	48
Functional Properties	48
Performance	48
Environmental according to IEC60945	49

8. Trouble Shooting 50

Basic System Integrity50

Installation problems51

Interface problems51

Basic functionality.....51

Typical Status Screen Contents52

Fig. 8.1 Typical contents of status screen 52

9. CPU Board Setup Procedure 53

CPU PCA 6742VE.....53

Master Reset Procedure54

Upgrading Software.....54

10. Service 55

11. Appendix 56

Miscellaneous Installation Drawings.....56

Fig. 11.1. EML224 System overview 57

Fig. 11.2. Terminal board connections..... 58

Fig. 11.3 Outline dimensions Display Unit 59

Fig. 11.4 Outline dimensions Electronic Unit 60

1. Introduction

System Summary

The SKIPPER EML224 is a navigational electromagnetic log system containing sensor (transducer), display (operator) unit and an electronic interconnection unit. The sensor can be delivered in many different versions to fit functionality demands and different hull installations. The display unit can be a larger unit with a high resolution LCD, or a smaller unit with dot-matrix LEDs. This manual only cover the version with the LCD unit.

The LCD can display a number of parameter in both numerical and graphic forms. The information from the electromagnetic sensor includes longitudinal and transversal speeds, drift angle and sea temperature. It is thus possible to get a very good picture of the vessels total movements.

The EML224 electromagnetic log will give direction of speed in both axis (ahead/astern and starboard/port). This is of great importance during manoeuvring or when running at low speeds. The speed range is the same astern and ahead. The user may select display text languages as well as various units of measure. All IMO requirements are met or exceeded. Comprehensive interfaces are available including NMEA 0183 input and output.

Sensor

The sensor is an active electromagnetic unit that can be fitted into various tank or sea valve solutions. The sensor is virtually maintenance free, but occasional cleaning may be necessary depending on sea water conditions. Ordinary fouling will be limited, due to the electromagnetic field surrounding the sensor. The sensor has no moving parts and protrudes only a few millimetres outside the hull. The sensor is interfaced through an electronic unit which also contains the power supply. This unit is mounted near the hull fitting, and two twisted pairs of cable are led to the display/operator unit for digital signal transmission. The power consumption of the electronic unit is max. 35W. Voltage 115/230 V AC and/or 24 V DC.

Operator Unit

The operator unit contains a colour TFT LCD display, a keyboard with fixed keys, softkeys and a rotating encoder. The function of each softkey depends on the active screen, and the buttons are labelled on the lower rim of the LCD. The display is backlit and backlight intensity may be adjusted by the user for both day and night vision. Various user-selectable information layouts, adapted to typical operational situations, may be displayed continuously on the LCD screen. The operator unit is normally flush mounted. Operator unit power supply options are 115/230 V AC or 24V DC. The power consumption is max. 70 Watts at 115/230 V AC and/or 50 Watts at 24V DC.

Data Entry

Several screens may be selected to enter various settings and calibration parameters. Each screen has one or more softkey menus, selectable with the leftmost "Menu" softkey. Screen A and B are primary operation screens with appropriate operator controls. Screen COM, STATUS and CALIBRATION are setup and system supervision screens. The various screens will be described in detail later.

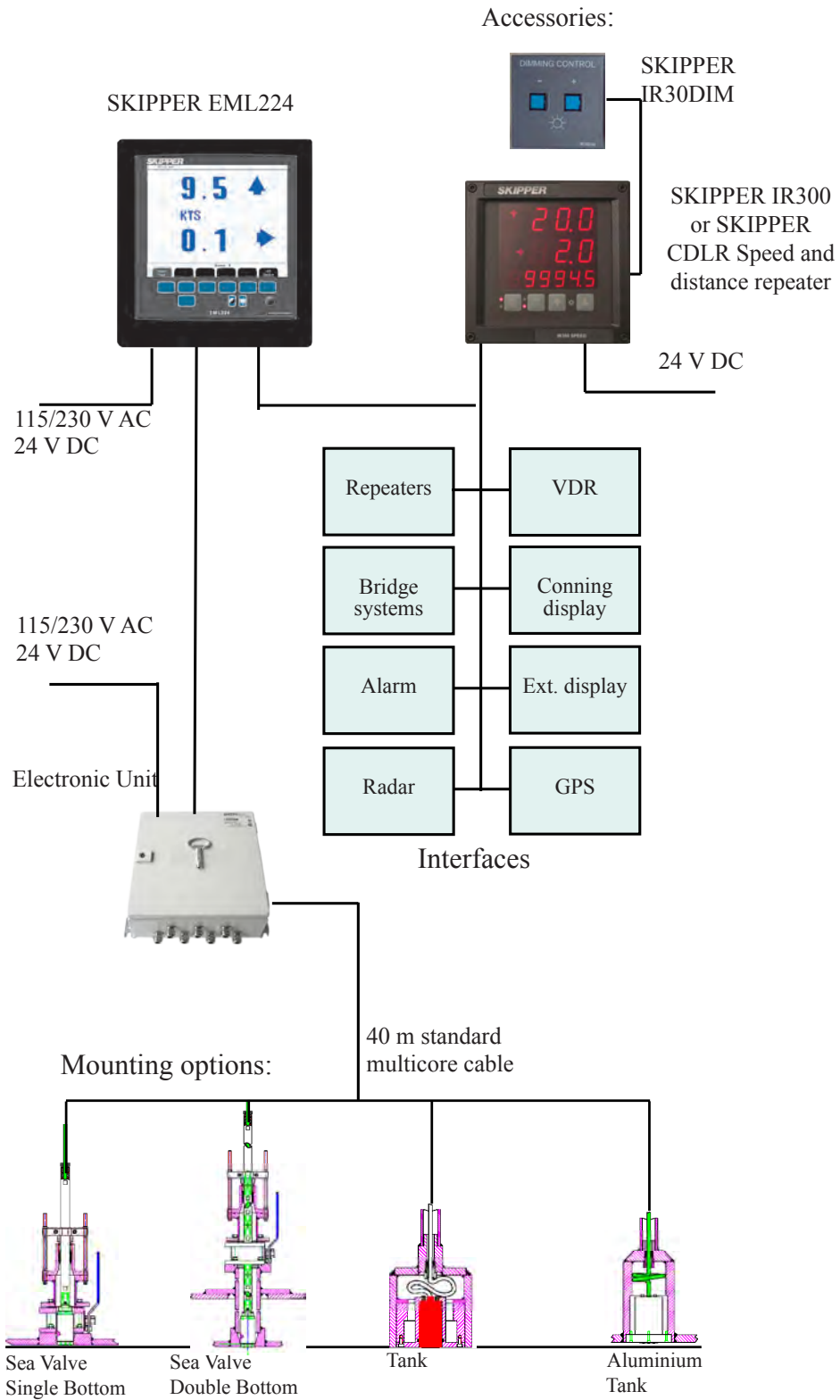

Fig. 1.1 System Overview

Interfacing

The EML224 has various interface possibilities.

Outputs

- 3 Log outputs 100/200/400/1000 pulses per nautical mile.
- 3 Analogue outputs 0-10 V or 4-20 mA.
- NMEA 0183 interface output
- External alarm relay output.

Inputs

- NMEA 0183 interface input.
- Remote alarm reset.

Alarms

- High and low speed alarms may be selected from the menus.
- Input for remote alarm reset is available.

A potential free relay contact is provided in EML224 for interface to external alarm systems.

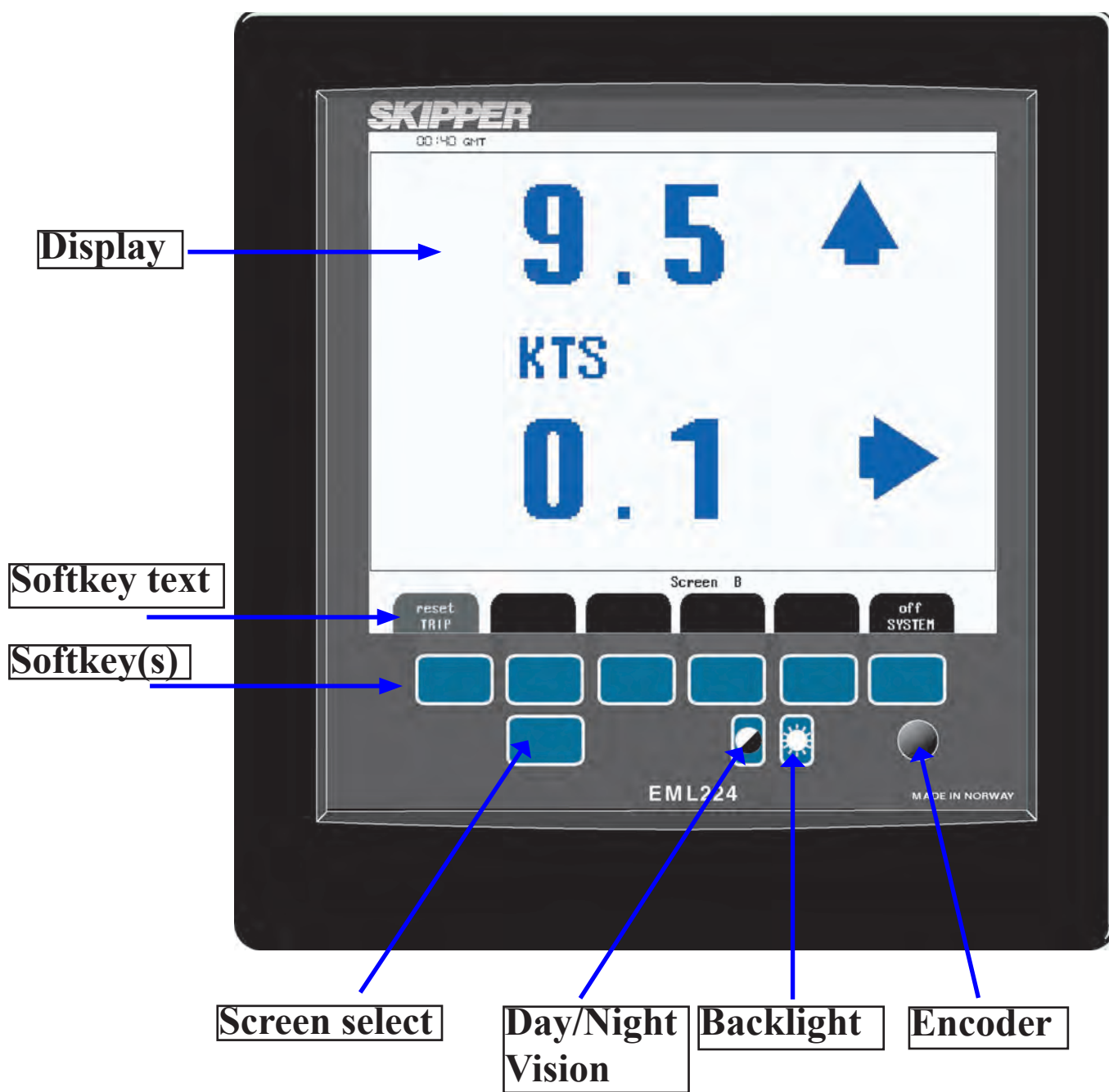

Fig. 1.2. Display unit panel layout

2. Operation

When the installation is complete, and power is connected to the operator unit, the system is switched on by pressing any button. The unit is switched off by pressing the “SYSTEM off” softkey on screen A and screen B.

Parameter entry

The fixed function buttons and the softkey(s) on the various screens along with the rotating encoder, facilitates entry of parameters, setpoints and other data. The following flowchart illustrates the procedure for changing settings and entering data. The various screens are shown in detail in the operation section.

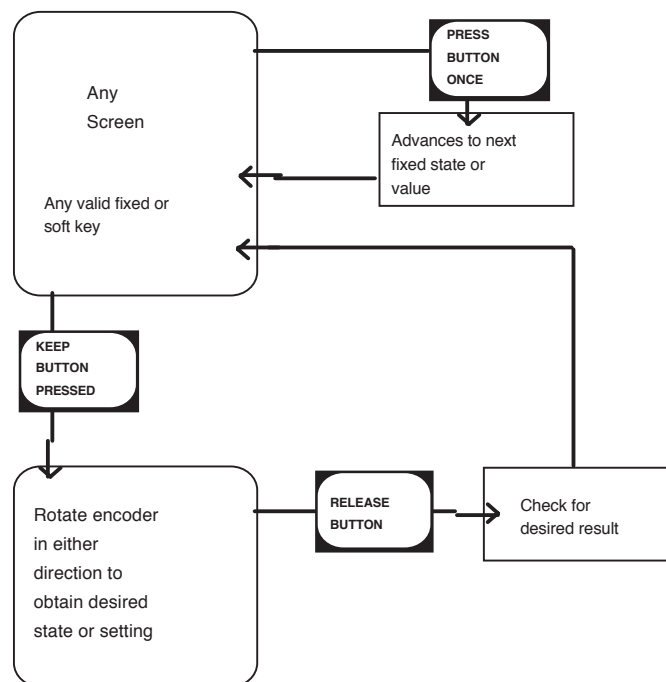

Fig. 2.1 Setting and Parameter Entry Flowchart

Example of parameter entry.

Suppose you want to enter a value of 15 kts for the high speed alarm. Press a high speed alarm softkey, e.g. in screen status, menu 1, and keep it pressed while you turn the encoder until you reach 15 kts, let go of the encoder and release the high speed alarm button.

Buttons with less than 6 possible states or values can be operated without using the encoder at all.

Operation Screens

Each of the operation screens contains a graphic picture and one or more menu sets configured on the 6 softkey buttons. The various screens are selected by keeping the SCREEN SELECT button pressed and rotating the encoder in either direction. Turning the encoder clockwise cycle the screens in the sequence 1 to 5, and counter clockwise rotation cycles the screens in the sequence 5 to 1. Screens A and B, covering the primary functions, may also be cycled by repeatedly pressing the SCREEN SELECT button. Screen COM, STATUS and CALIBRATION is mainly used for setup and function control, and may only be accessed by the rotating encoder.

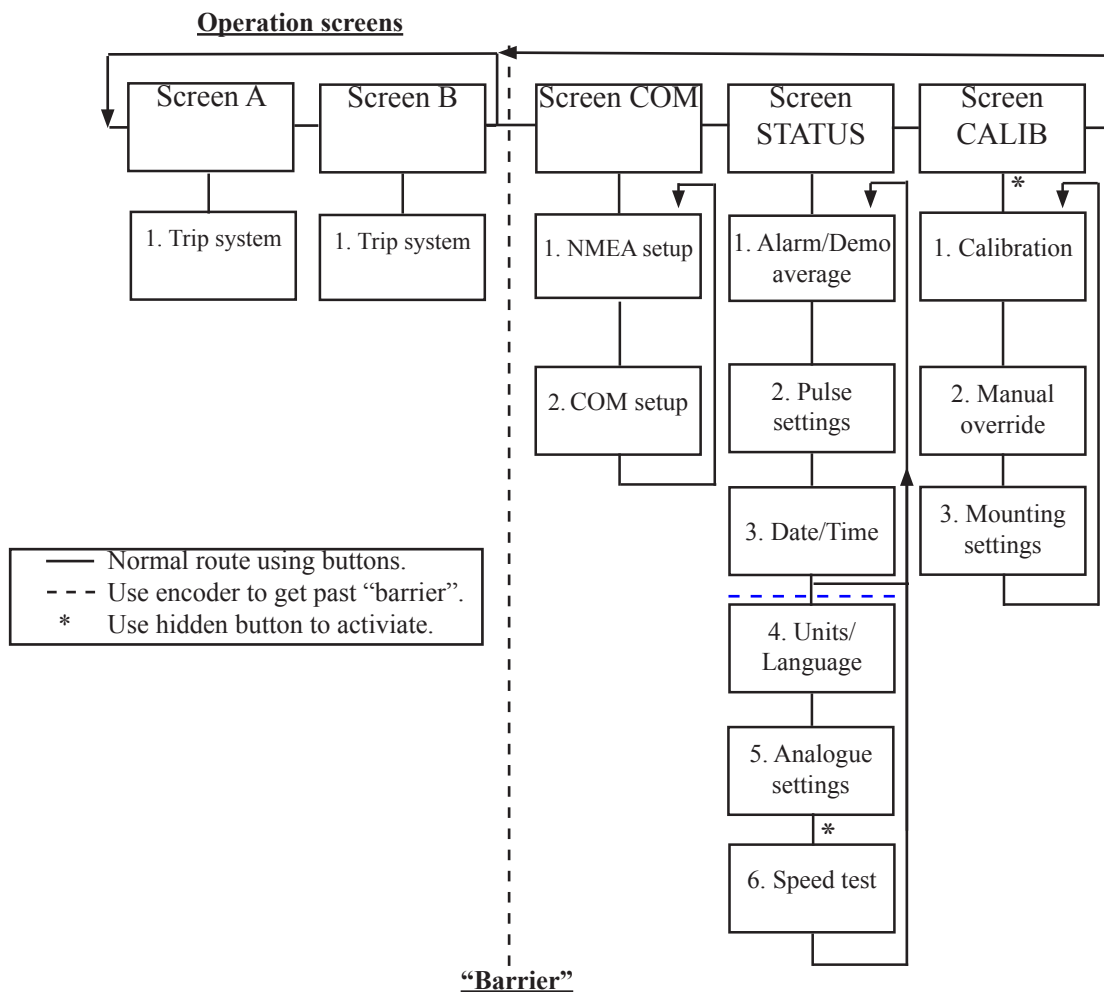

Fig. 2.2. Schematic overview of screens and softkey menus

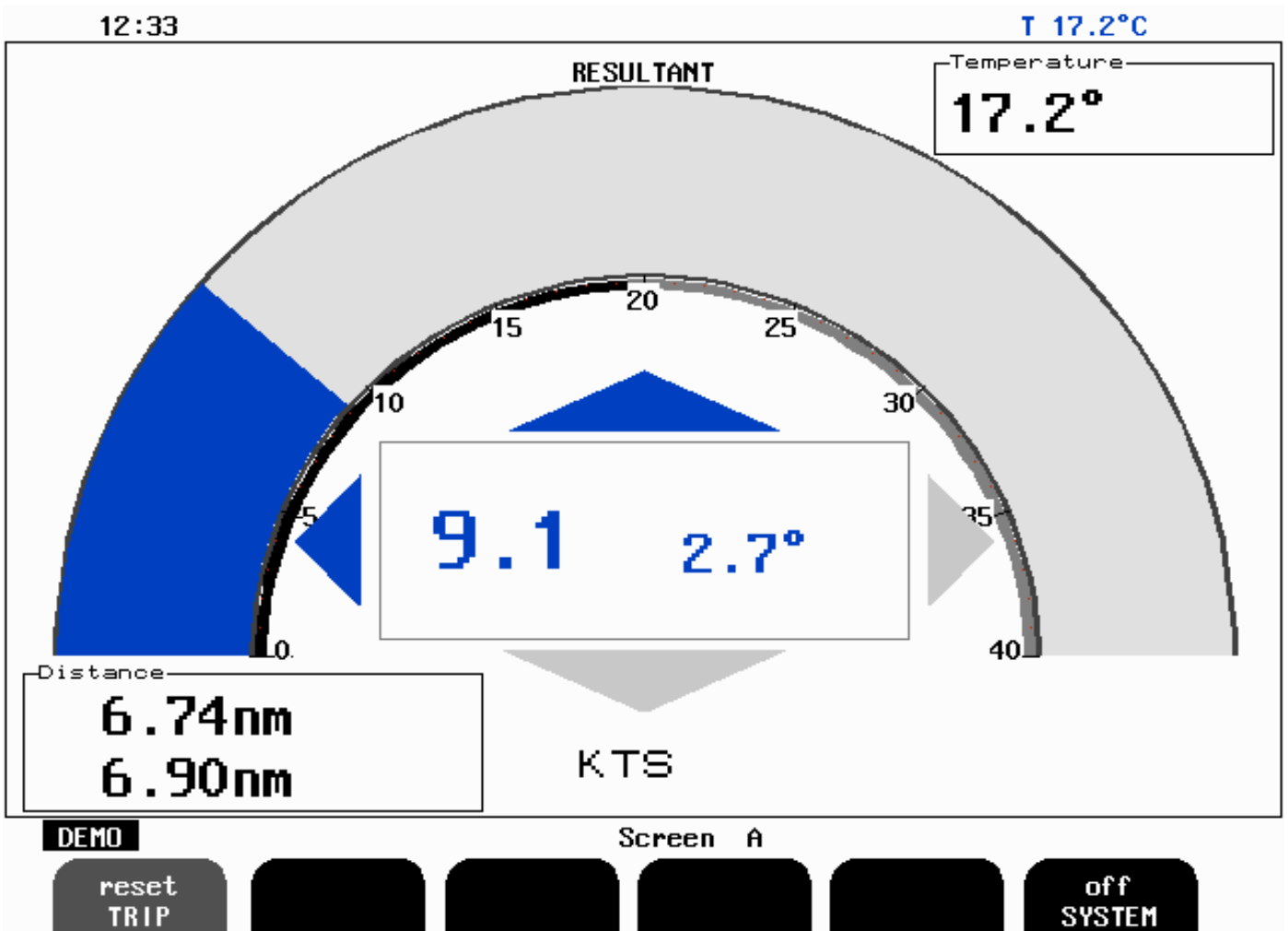

Fig. 2.3. Screen A

Softkey	Name	Range/value	Default value	Description
1	TRIP	Reset		Trip distance counter reset.
2				Not used.
3				Not used.
4				Not used.
5				Not used.
6	SYSTEM	On/off	On	System off.



Fig. 2.4. Screen B

Softkey	Name	Range/value	Default value	Description
1	TRIP	Reset	Reset	Trip distance counter reset.
2				Not used.
3				Not used.
4				Not used.
5				Not used.
6	SYSTEM	On/off	On	System off.

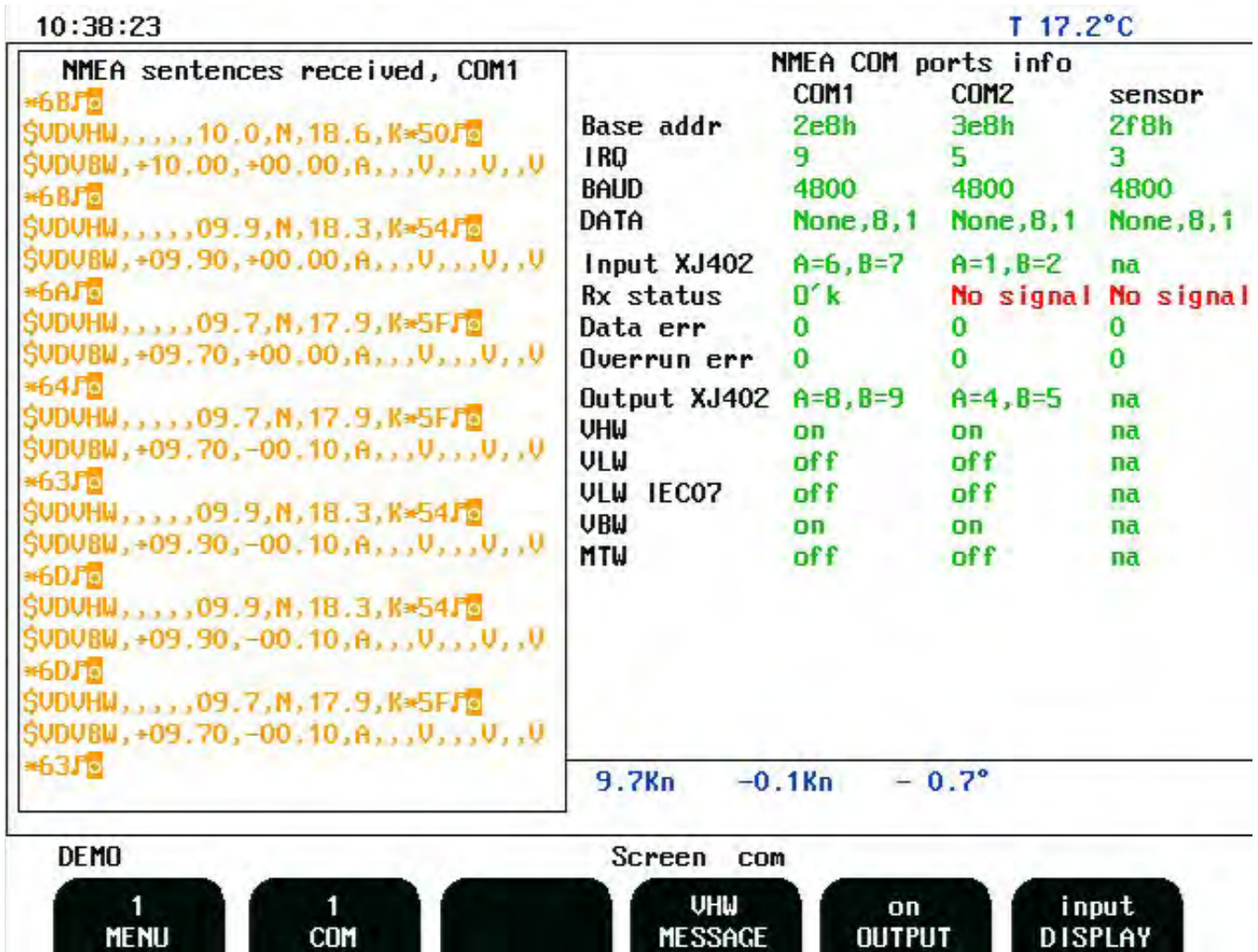

Fig. 2.5 A. Screen Com, Menu 1

Softkey	Name	Range/value	Default value	Description
1	MENU	1 - 2	1	Chosen menu number 1.
2	COM	1 - 2	1	Serial port number referred by other keys.
3				Not used.
4	MESSAGE	VHW, VLW, VLW IEC07, VBW, MTW		NMEA message selector. Each message may be controlled individually by softkey 5.
5	OUTPUT	On/off	VHW: on VLW: off VLW IEC07: off VBW: on MTW: off	Setting for the message in softkey 4 [On/Off] Note: To configure the serial output of the system, go through all the messages by pressing soft key 4 and set on/off value of the softkey 5 to disable/enable a message as required.
6	DISPLAY	Input, off, output	Output	Selects the information (received from the external source or transmitted by the EML224) to be displayed in the "TEXT" window. <ul style="list-style-type: none"> Input: Displays information received from external source. Output: Displays information transmitted by EML224. Off: None.

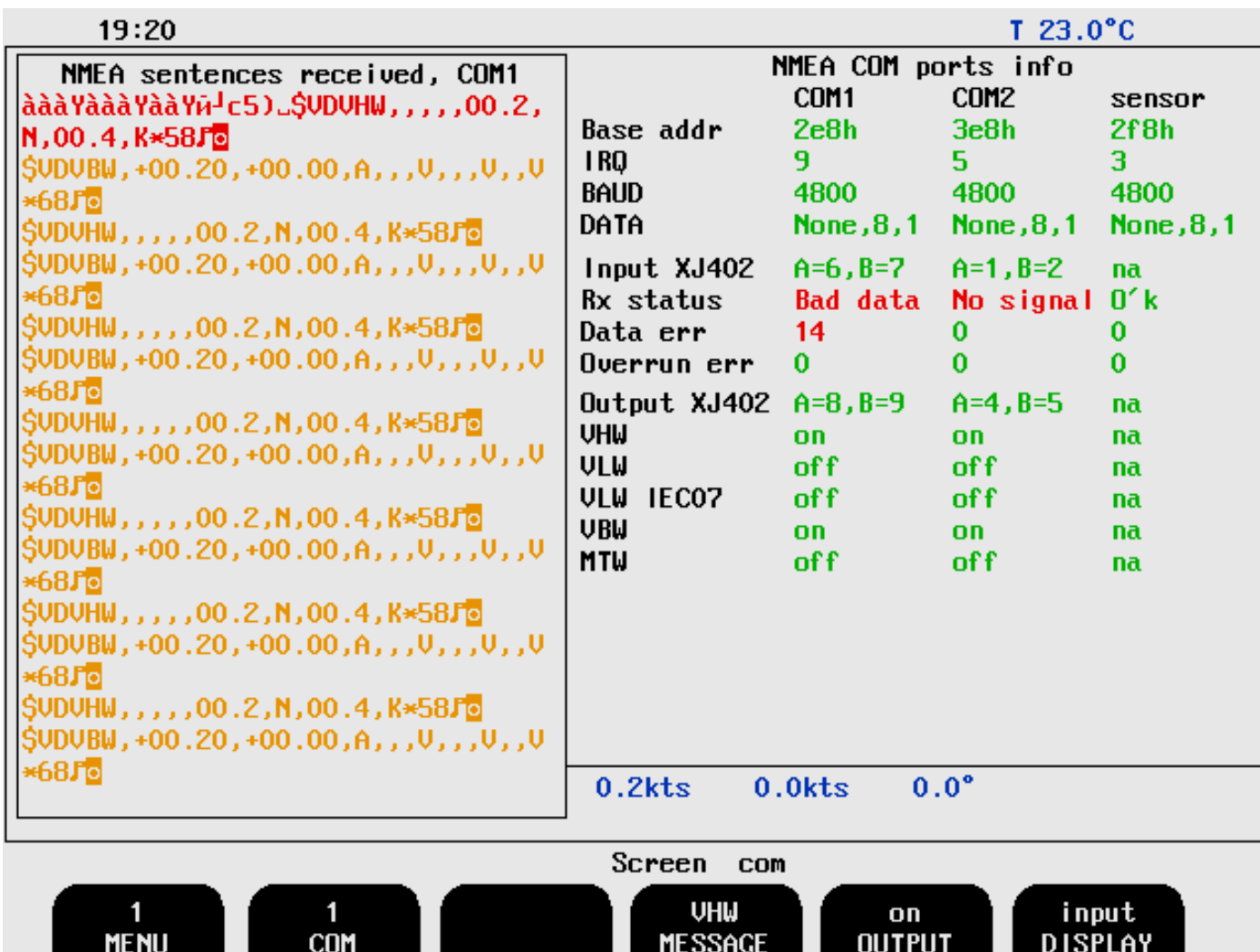

Fig. 2.5 B. Screen Com, Menu 1 Error/Warning messages

The right side of the screen shows the status of the available COM ports and the sensor. Showing in green which pins the ports are connected to on D-SUB type connector XJ402. Active NMEA protocols are also shown. The text window on the right side, when set to input DISPLAY, indicates what is being received and recognised by the unit.

- Accepted messages are shown in black type if the sentence is correct.
- Not of a recognised format, the text is orange
- If something is wrong with the sentence, such as format or checksum, the text is in red.

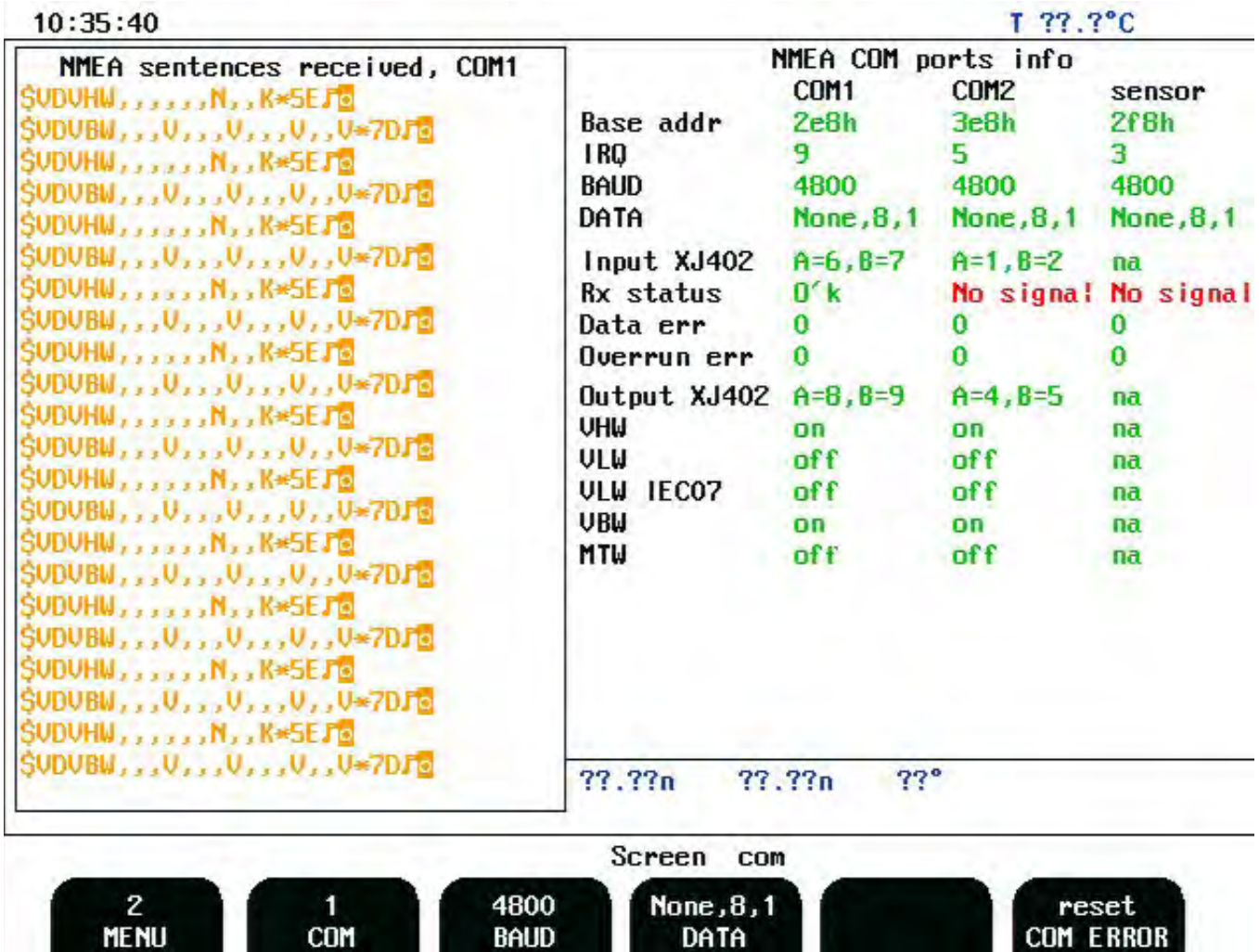

Fig. 2.6. Screen Com, Menu 2

Softkey	Name	Range/value	Default value	Description
1	MENU	1 - 2	2	Chosen menu number 2.
2	COM	1 - 2	1	Serial port # referred by other keys.
3	BAUD	1200, 2400, 4800, 9600, 19200, 38400, 56700, 115200.	4800	Baudrate for COM port #n.
4	DATA	None-7-1, Even-7-1, Odd-7-1, None-8-1, Even-8-1, Odd-8-1, None-7-2, Even-7-2, Odd-7-2, None-8-2, Even-8-2, Odd-8-2,	None, 8, 1	Data format for COM port #n (Parity-data bits-stop bits).
5				Not used.
6	COM ERROR	Reset		The program memorizes the latest occurred NMEA input error for further analysis (error code presented on the status and com screens). By using this softkey, it is possible to reset the error.

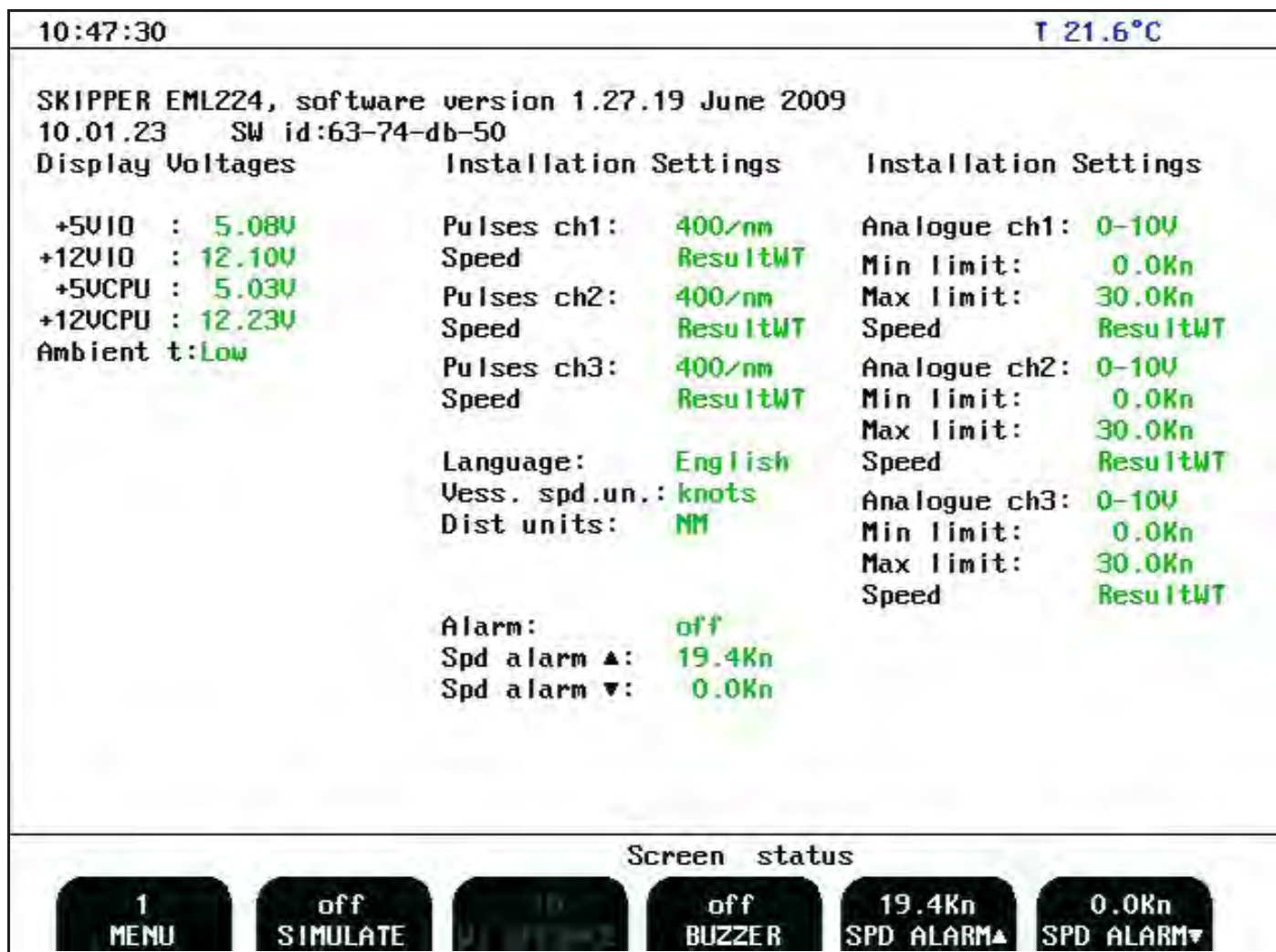

Fig. 2.7. Screen Status, Menu 1

Softkey	Name	Range/value	Default value	Description	Activate with hidden button
1	MENU	1 - 6	1	Chosen menu number 1.	
2	SIMULATE	On/off	Off	Built-in simulator on/off.	
3	WT AVERAGE	0 - 100	10	Number of individual samples to be averaged in water track mode to provide better accuracy.	Yes
4	BUZZER	On/off	Off	Buzzer alarm on/off.	
5	SPD ALARM ▲	0.1 - 38.9 Kn	19.4 Kn	High speed alarm.	
6	SPD ALARM ▼	0.0 - 38.8	0.0 Kn	Low speed alarm.	

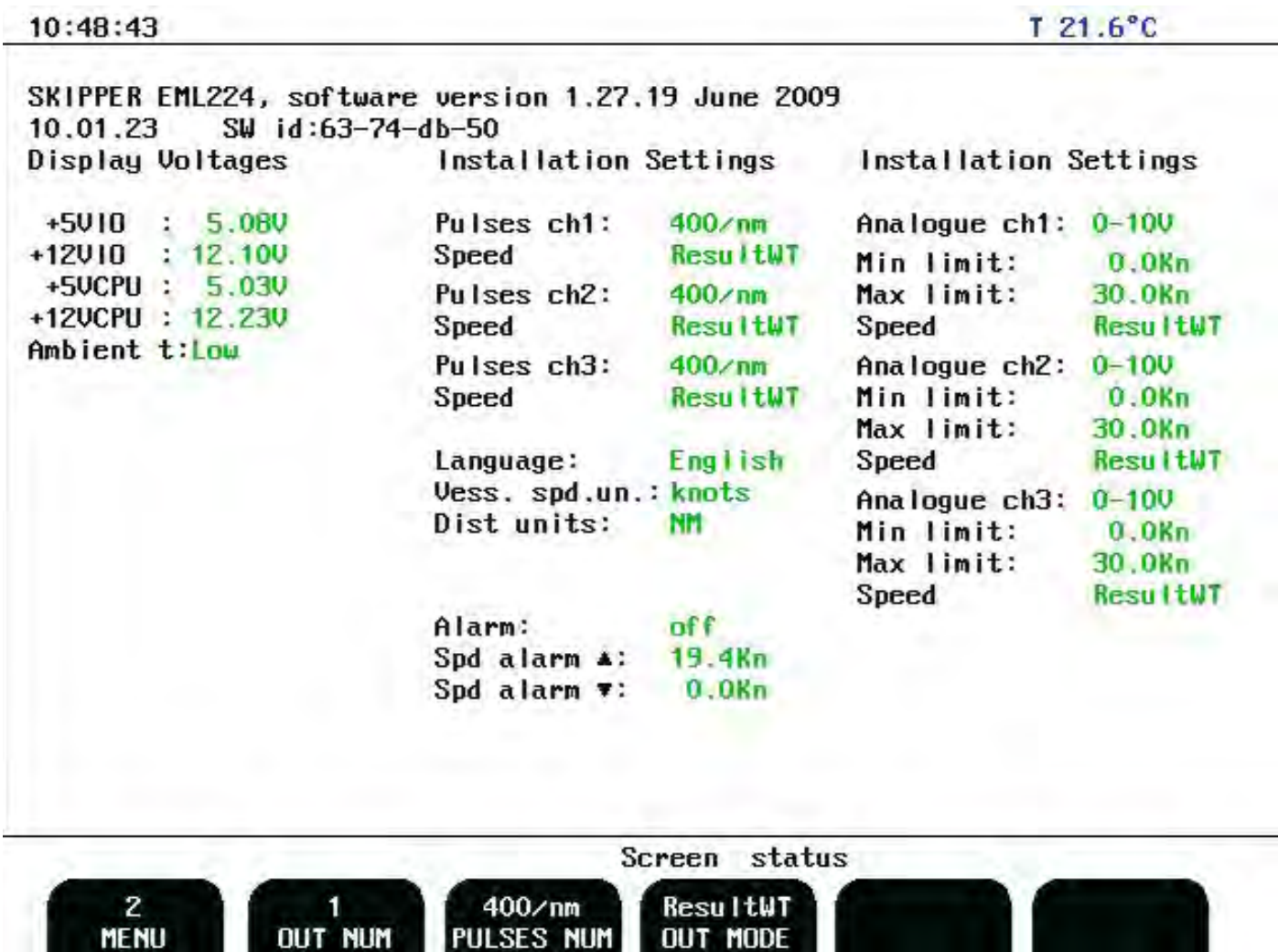

Fig. 2.8. Screen Status, Menu 2

Softkey	Name	Range/value	Default value	Description
1	MENU	1 - 6	2	Chosen menu number 2.
2	OUT NUM	1 - 3	1	Pulse output channel to be configured by keys 3 and 4.
3	PULSES NUM	10, 100, 200, 400, (1000)/nm	400/nm	Number of pulses per nautical mile at this channel (key 2). Channel 1 and 2 are programmable with 10, 100, 200 and 400 pulses per nautical mile. Channel 3 are programmable with 10, 100, 200, 400 and 1000 pulses per nautical mile.
4	OUT MODE	ResultWT, ForAftWT, LateralWT,	ResultWT	Speed parameter to be output at this channel (key 2).
5				Not used.
6				Not used.

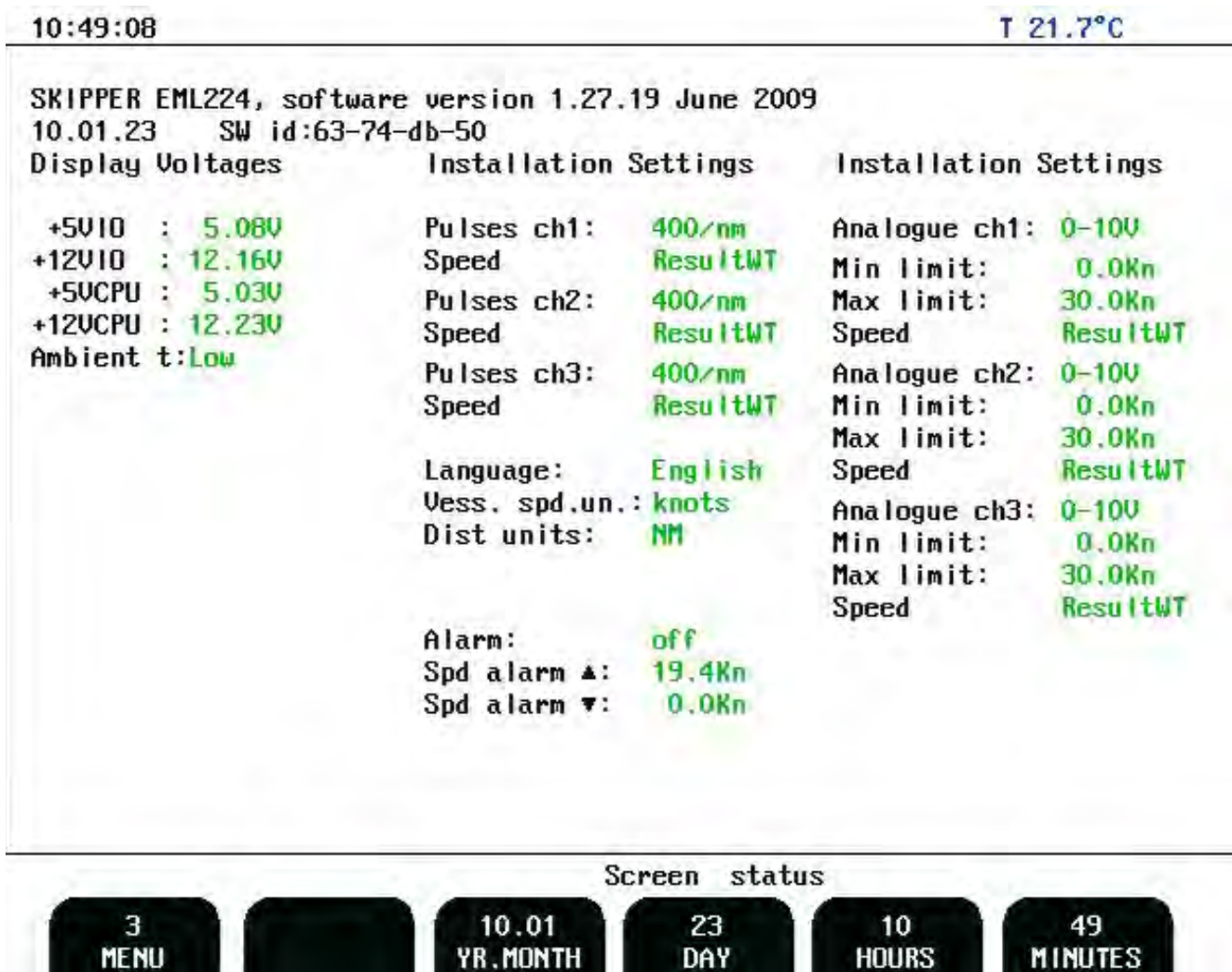

Fig. 2.9 Screen Status, Menu 3

Softkey	Name	Range/value	Default value	Description
1	MENU	1- 6	3	Chosen menu number 3.
2				Not used.
3	YR.MONTH			Year and month setting.
4	DAY			Date setting.
5	HOURS			Hours setting.
6	MINUTES			Minutes setting.

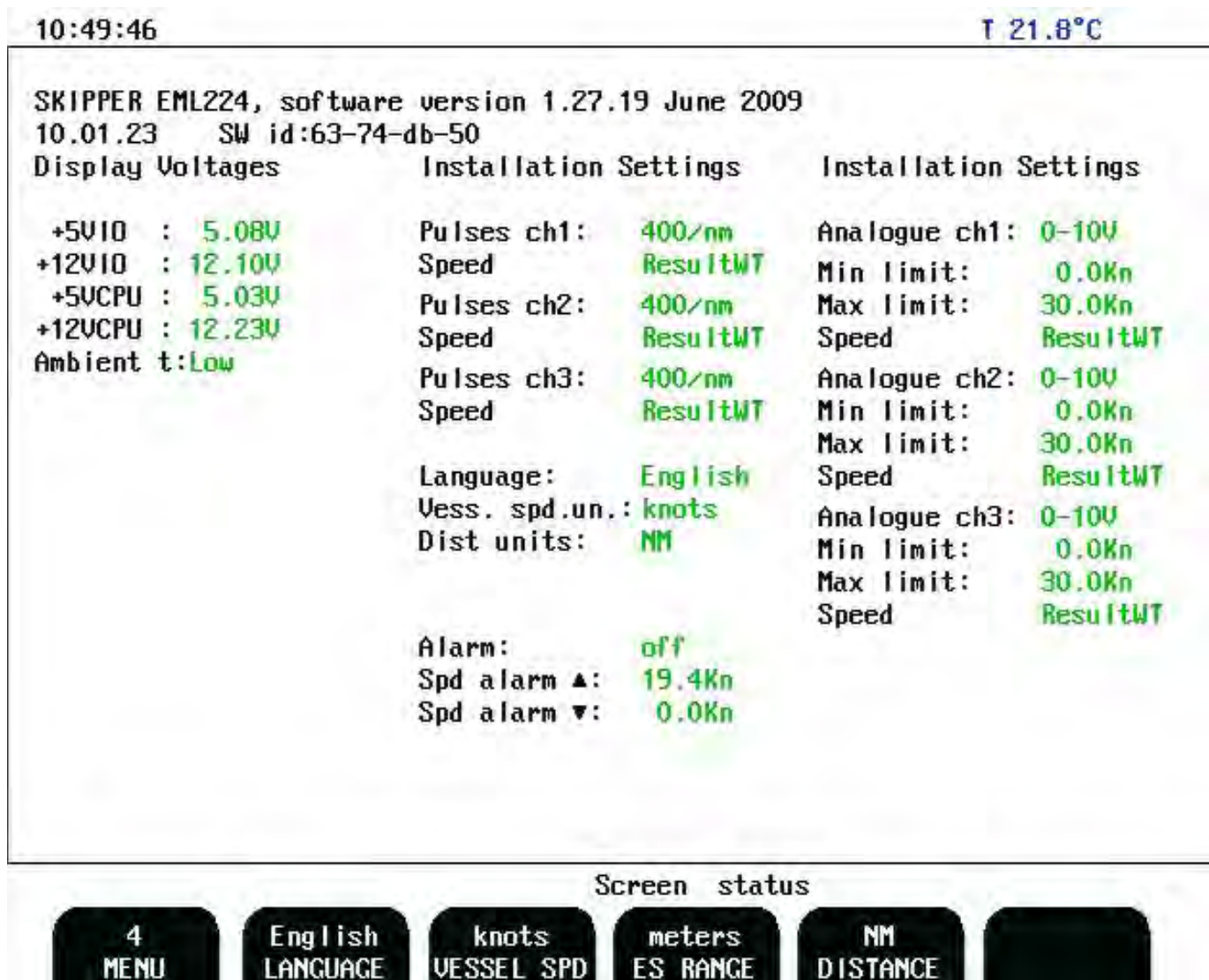

Fig. 2.10. Screen Status, Menu 4

Softkey	Name	Range/value	Default value	Description
1	MENU	1 - 6.	4	Chosen menu number 4.
2	LANGUAGE	English, French, Spanish, Russian, German, Scandinavian.	English	Select display language.
3	VESSEL SPD	Knots, km/h, mi/h, m/sec.	Knots	Select speed unit.
4	ES RANGE	Meters, feet, fathoms, braccias.	Meters	Select depth unit.
5	DISTANCE	NM, km, mi.	NM	Select distance unit.
6				Not used.

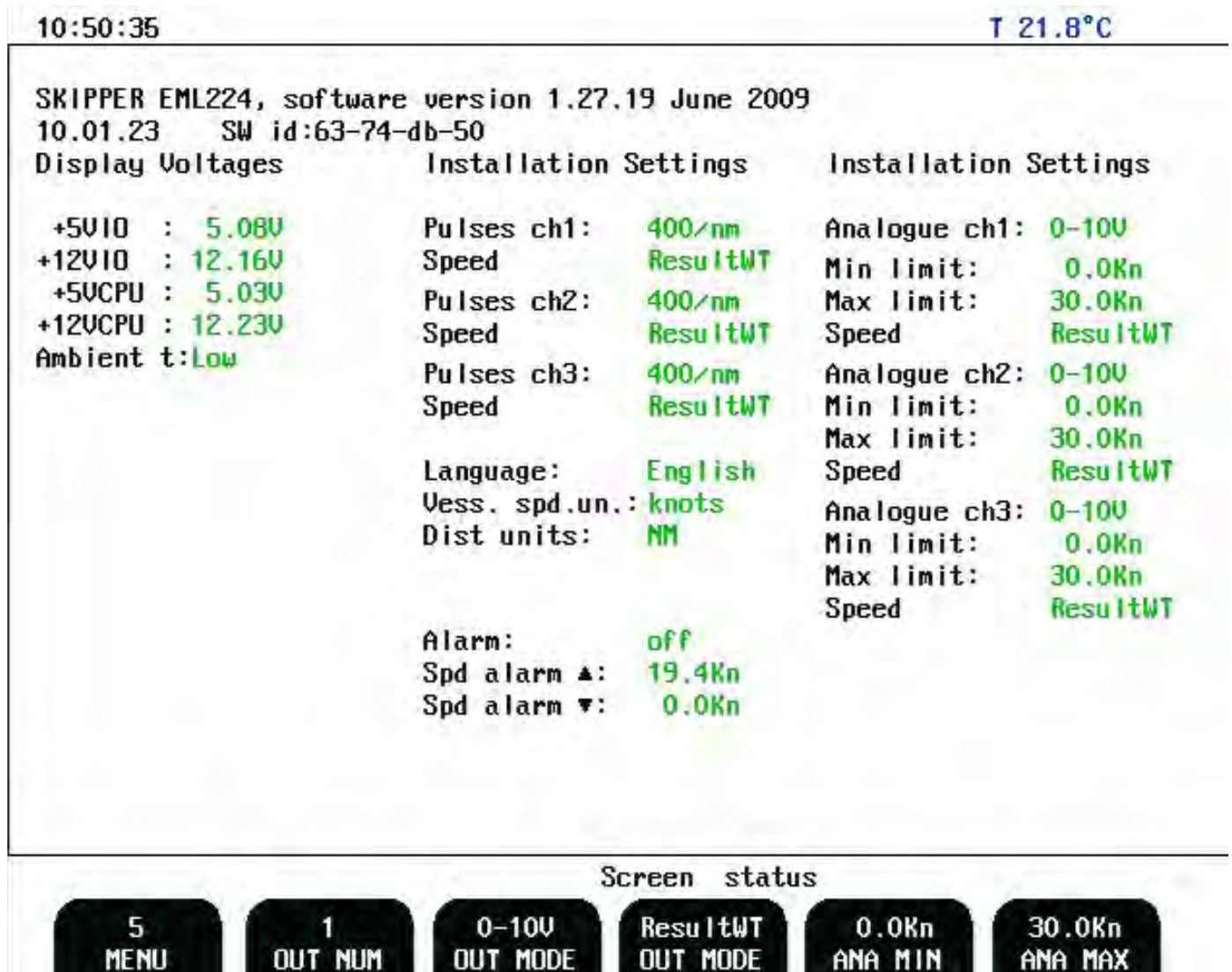

Fig. 2.11. Screen Status, Menu 5

Softkey	Name	Range/value	Default value	Description
1	MENU	1 - 6	5	Chosen menu number 5.
2	OUT NUM	1 - 3	1	Analogue output channel to be configured by keys 3 - 6.
3	OUT MODE	0 - 10 V 4 - 20 mA	0 - 10 V	Output mode selection for this channel (key 2).
4	OUT MODE	ForAftWT, Lateral/WT, ResultWT	ResultWT	Speed Parameter to be output at this channel (key 2).
5	ANA MIN	-48.6 - 48.6 Kn	0.0 Kn	Speed value for minimum output at this channel (key 2).
6	ANA MAX	-48.6 - 48.6 Kn	30.0 Kn	Speed value for maximum output at this channel (key 2).

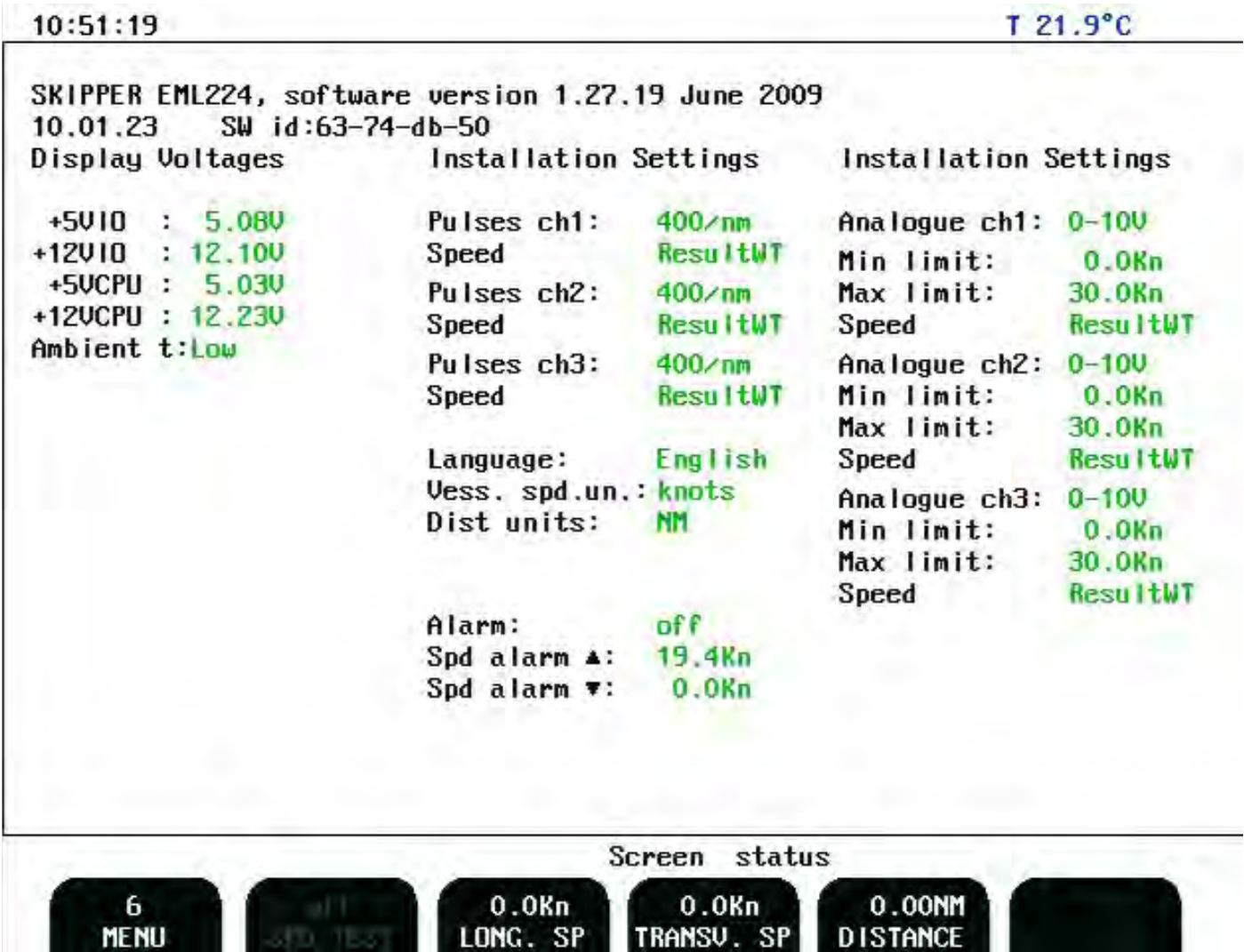

Fig. 2.12. Screen Status, Menu 6

Functions described below can be used during commissioning period to test different outputs with constant, user adjustable speed values. **Note:** When the test mode is activated, this will be indicated by flashing “TEST” label in the lower left part of the screen.

Softkey	Name	Range/value	Default value	Description	Activate with hidden button
1	MENU	1 - 6	6	Chosen menu number 6.	
2	SPD TEST	On/off	Off	Toggling test mode on/off.	Yes
3	LONG. SP	-40.0, -20.0, -15.0, -10.0, -5.0, 0.0, 5.0, 10.0, 15.0, 20.0, 40.0,	0.0 Kn	Select test value of longitudinal speed	
4	TRANSV. SP	-5.0, -4.0, -2.0, -1.0, -0.5, 0.0, 0.5, 1.0, 2.0, 4.0, 5.0,	0.0 Kn	Select test value of transversal speed	
5	DISTANCE	0.00, 9.99, 99.99, 999.99, 9999.99, 99999.99	0.00 NM	Select test value of distance.	
6				Not used	

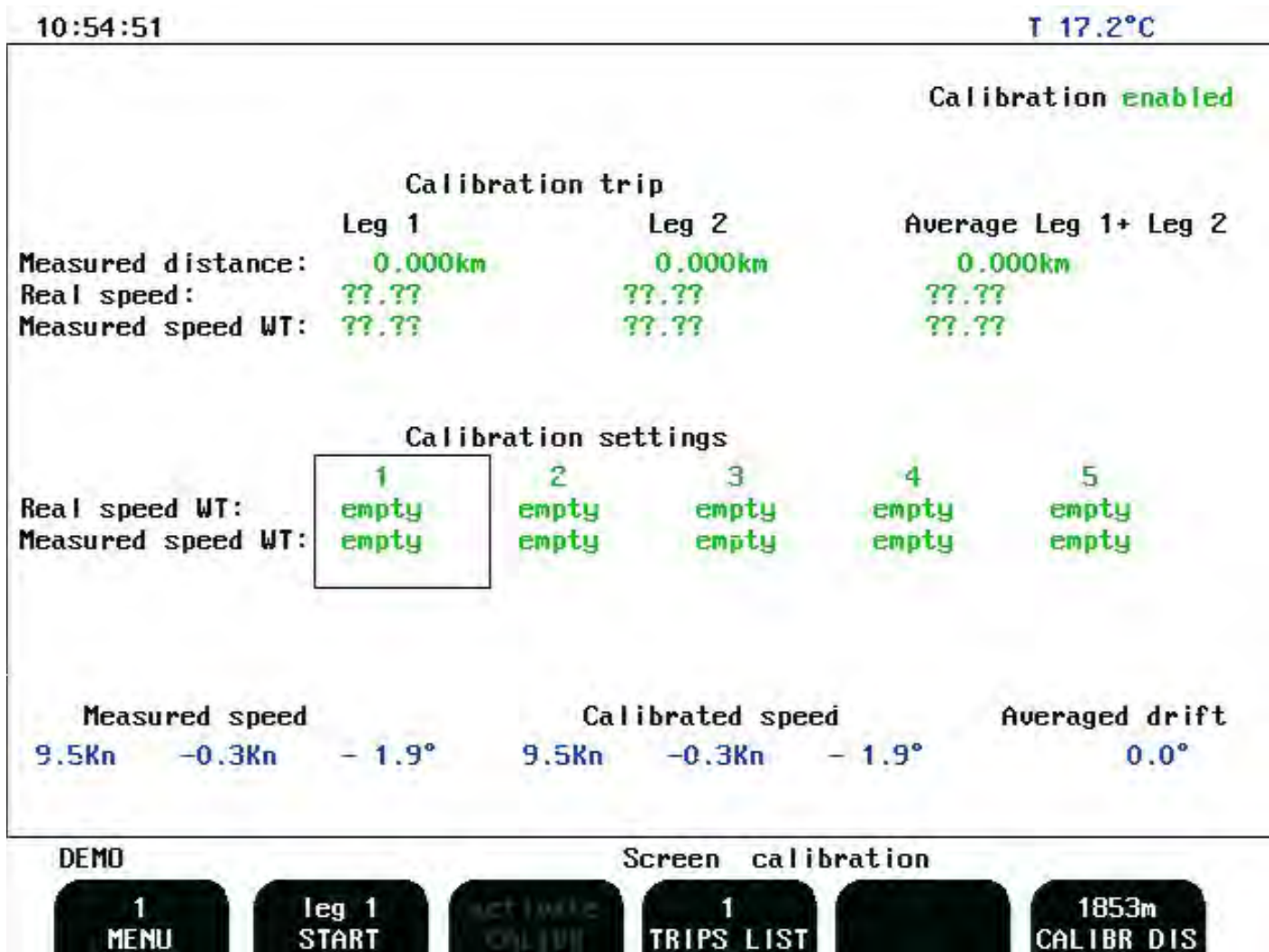

Fig. 2.13. Screen Calibration, Menu 1

Softkey	Name	Range/value	Default value	Description	Activate with hidden button
1	MENU			Chosen menu number 1.	
2	START	Leg 1 start/finish Leg 2 start/finish	Leg 1	Used to start/finish test trip.	Yes
3	CALIBR			Used to move data, collected during test trip into calibration table.	
4	TRIPS LIST	1 - 5	1	Used to list between different test trip data sets. Only one test trip is displayed on the screen at a time.	
5				Not used.	
6	CALIBR DIS	100 - 10000	1853 m	Used to adjust length of the test leg.	

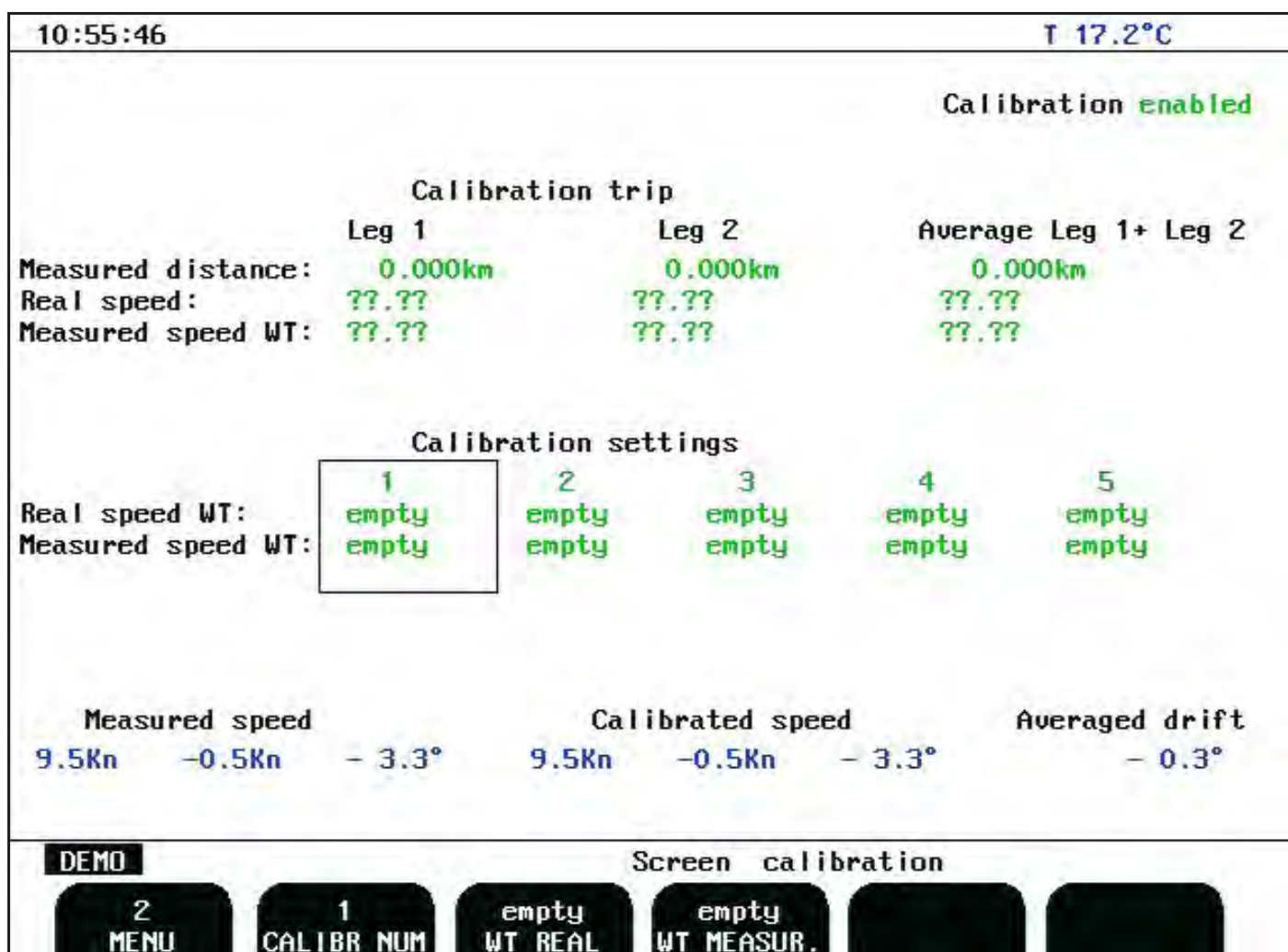

Fig. 2.14. Screen Calibration, Menu 2

Softkey	Name	Range/value	Default value	Description
1	MENU	1 - 3	2	Chosen menu number 2.
2	CALIBR NUM	1 - 5	1	Number of the calibration, currently available for adjustments. In the calibration table it is marked by the frame.
3	WT REAL	Empty, 0.0 - 38.9	Empty	Real ship's WT speed.
4	WT MEASUR	Empty, 0.0 - 38.9	Empty	WT speed, measured by the system (not calibrated).
5				Not used.
6				Not used.

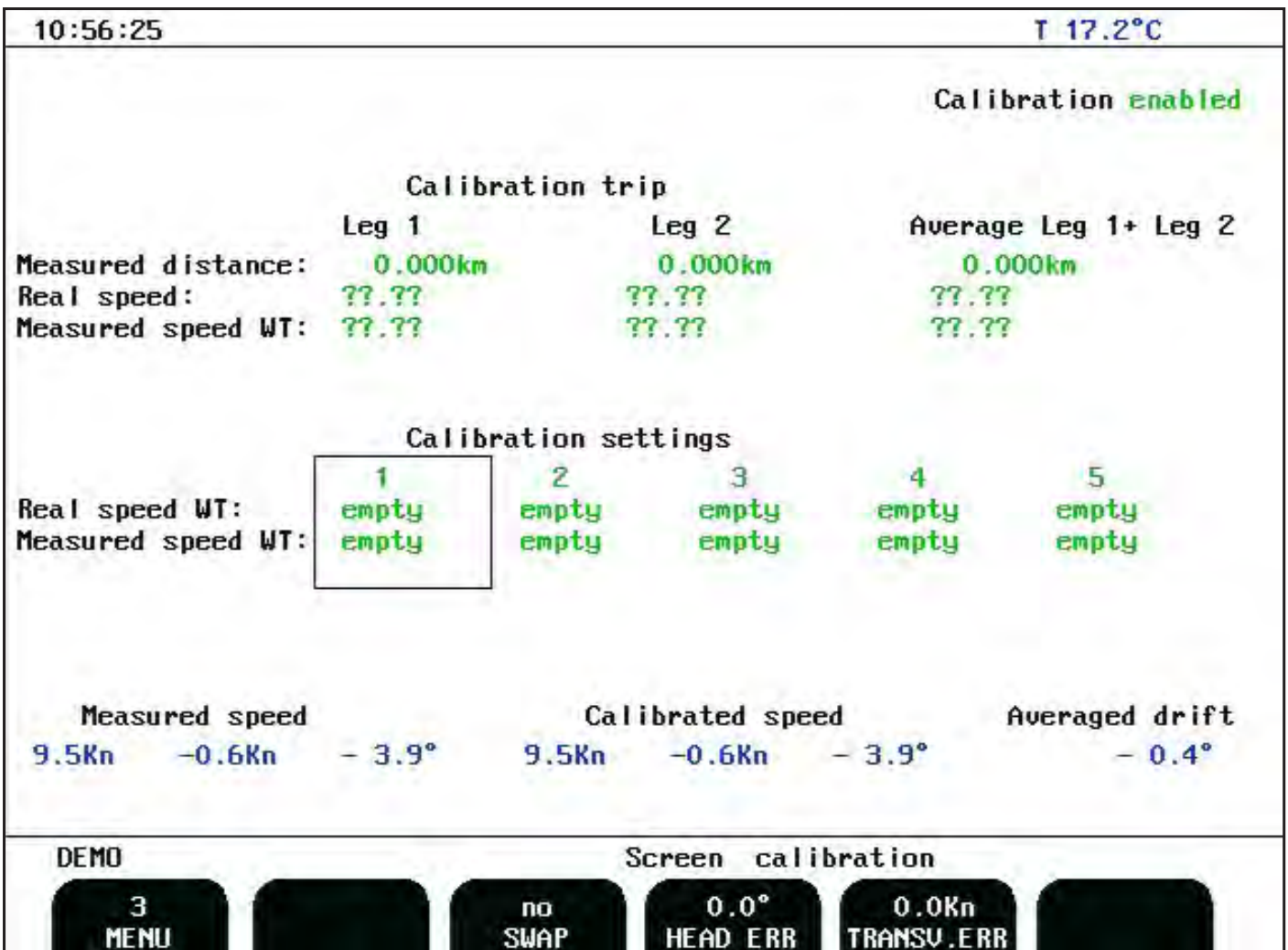

Fig. 2.15. Screen Calibration, Menu 3

Softkey	Name	Range/value	Default value	Description
1	MENU	1 - 3	3	Chosen menu number 3.
2				Not used.
3	SWAP	No, p-s, f-a, p-s/f-a,	No	Sensor elements swap.
4	HEAD ERR	0.0 - 30.0	0.0 °	Installation angular error correction.
5	TRANSV. ERR	0.0 - 38.9	0.0 Kn	Installation transversal error correction.
6				Not used.

Principal Functions

Principles of Electromagnetic Log

The sensor of the electromagnetic log creates a magnetic field in the water. When the ship moves, the stream of water running along the hull cuts this magnetic field and generates a difference in potential between the sensor electrodes. This difference is directly proportional to the speed of the stream of water. Calibration of the log makes it possible to correct the difference between the water speed around the transducer and the speed of the ship. These differences being essentially linked to the positioning of the transducer in relation to the hull and also to the hull's shape.

Power ON/OFF

During normal daily operation, the system may be switched off from all operation menus. This operation does not disconnect the system from the power supply, but all power consuming components are switched off. The system may be switched on again by pressing any button.

Alarm acknowledgement

When any alarm is activated, the alarm may be acknowledged by pressing any button. An alarm can also be silenced by using a remote alarm button, but the alarm message will still be present until a button is pressed on the operator unit.

Fixed Key Functions

Screen Select

The SCREEN SELECT button facilitates selection of one of the five screen and softkey layouts. The 2 primary operation screens may be cycled by repeatedly pressing the SCREEN SELECT button. Access to the remaining screens is through encoder operation. The screens are cycled in an endless, bidirectional loop, e.g. turning the encoder counter-clockwise, will open the last screen after the first screen. Turning the encoder with no buttons pressed always force screen A.

Backlight adjustment

Backlight may be continuously controlled by using the appropriate button and the encoder. Press the button and rotate the encoder until a satisfactory setting is obtained, then release the button. The settings are maintained in the nonvolatile memory, and the last settings are restored on power up. Backlight may be adjusted in both day and night vision.

Day/Night

Day/Night vision may be selected by pressing this button.

Key Functions

Menu

On some screens, the leftmost softkey is used for selecting the desired menu, i.e. softkey layout within a screen. The different screens have a different number of menus, and some of the menu functions may be available on more than one menu. Below is a list of all menu functions, not necessarily in the sequence they appear on the screens.

Trip Reset

This key is used to reset the trip distance counter.

Alarm Settings

Speed alarm settings are performed from status screen, menu 1. Alarm limits are referred to the indicated speed and depth. The local alarm buzzer may be disabled from status screen, menu 1, but the external alarm relay will always operate. The only way to disable the alarms completely, is to reduce the low speed alarm to zero and increase the high speed alarm to maximum range. An active low speed alarm must be less than an active high speed alarm. Alarm limits are enforced with hysteresis.

Clock and Calendar Settings

Manual clock and calendar adjustments are carried out in the status screen menu 3. If a satellite navigator giving UTC messages is connected to the NMEA input, the clock and calendar will be automatically updated and manual adjustment is not required.

Simulator

The EML224 contains a built in simulator to test the screen indicators and various interface signals. The simulator may be switched on and off on status screen menu 1. When the simulator is operating, "Demo" is flashing at the bottom of the screen.

Status Screen

The Status Screen shows a list of various system parameters useful for documenting system set-up and system operating status. The contents of this screen will be valuable information in situations where manufacturer support is required.

Nonvolatile Parameter Memory

The system contains memory to maintain installation and user parameters like language and units of measurement selection, backlight settings, etc. These parameters are automatically restored on power up. If the user parameters have never been set, default values are used.

Options

Repeaters/speed and distance

Digital repeaters may be connected to the system.

3. User Maintenance

Sensor Maintenance

The sensor is virtually maintenance free, but occasional cleaning may be necessary depending on sea water conditions.

Operator Unit Maintenance

The operator unit contains no user serviceable parts, and requires no maintenance apart from occasional cleaning of the front panel. Please use a soft cloth and no chemicals except cleaning alcohol.

4. Installation

Standard System Supply

A basic EML224 system consists of the following units:

- Display/Operator unit.
- Electronic unit.
- Sea valve with hull fitting sensor.

See chapter 9. Appendix, drawing: EML224 overview

Hull Fitting

Please see installation manuals (also found on our web site www.skipper.no) for chosen sea valve or tank solutions for dimensions and hull fittings.

Sensor Location

To facilitate the calibration procedure, the sensor should be installed close to the bulb or the stem of the ship, avoiding areas where it may be damaged by the anchor chain. It is necessary to select a part of the hull that is submerged under all load and speed conditions.

- The electronic unit have to be installed in a dry place.
- The sea valve with sensor can be installed in a water tank, but it is not recommended. SKIPPER will not be responsible if it is necessary to empty a tank in order to access the sensor for service purposes.
- It is necessary to position the sensor on a flat, horizontal hull section which is large enough to ensure a laminar water flow for all angles of drift.
- If such a flat section is not available, the shipyard must construct a suitable bed.
- If the vessel is designed with a box keel, this can be used for installation of the sensor.
- In this case, suitable hull fitting may be ordered from SKIPPER.

Before hull fitting installation procedure is initiated, always check that the sea valve can be properly operated and the sensor removed in the location selected. The required clearance to operate the valve and remove the sensor is shown in Fig. 10.3.

See installation manual for the sea valve solution for detailed information.

Part Positioning and Welding

Please see the installation manual for the hull fittings. Installation may differ between the different sea valve and tanks solutions available.

- **Note:** Do not paint the protruding part of the sensor and electrodes.

The Electronic Unit

The electronic unit contains the power supply PCB for the transducer. It must be installed fairly close to the hull fitting as the standard cable is 40 meters. The unit should be fitted on a vertical surface in a dry area. See chapter 9, appendix, for Miscellaneous Installation Drawings.

Sensor/Electronic Unit interconnection

- The sensor is connected to the electronic unit with the attached cable.
- The outer cable screen must be connected to the EMC cable gland.
- The EML log sensor cable can be cut or extended

Power supply for the Electronic Unit is 115/230 V AC and/or 24V DC.

The circuit board in the electronic unit is equipped with several LEDs indicating the state of various voltages and signals. Following list show the expected status of the LED lamps. Location is indicated in the wiring diagram Fig. 4.2 on next page.

LED	Colour	Signal	Description/Function
LD100	Green	Power	Voltage indicator. (Flashing at 2 Hz with the field inducting current).
LD200	Green	Data from sensor	On and flashing in accordance with data traffic.
LD300	Red	NMEA out	Flashing in accordance with data traffic.
LD301	Green	NMEA in	Flashing in accordance with data traffic.
LD302	Green	Data to sensor	On and Flashing in accordance with data traffic.

Transducer/Electronic Unit PCB

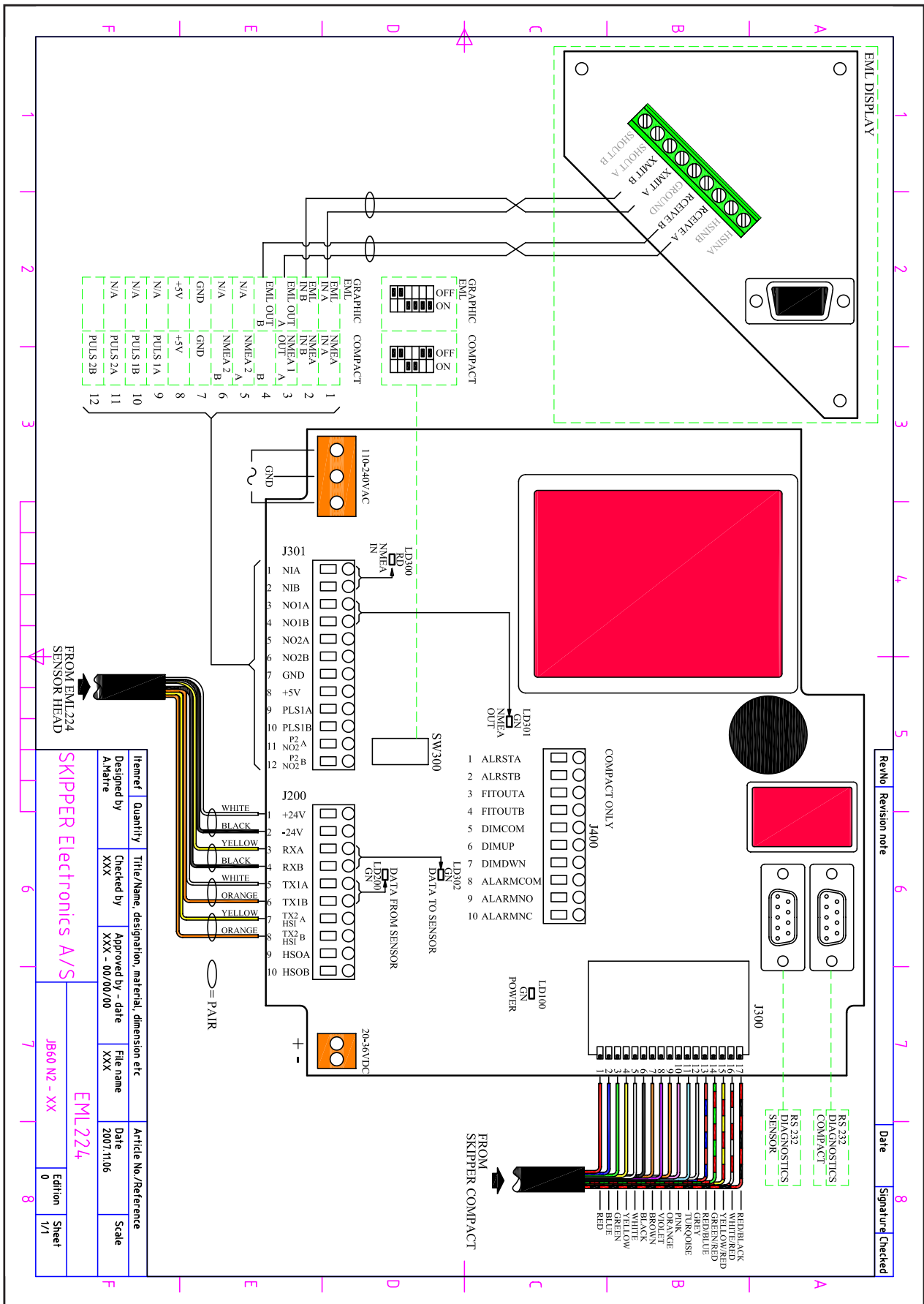

Fig. 4.2. Sensor /Electronic Unit, Wiring diagram.

Operator Unit Installation

Select a position to provide free view of the panel as well as easy access during operation and service. The operator unit may be mounted flush in a panel or directly onto a bulkhead. Fig. 10.3 shows the operator unit along with the main installation dimensions. If the unit is to be flush mounted, the shown cut-out and recession depth dimensions must be observed. Remember to leave room in front of the unit to open the door a full 90°

Do not perform installation work with system power applied!!

Cables are fed through the appropriate cable glands as follows:

- The cable from the transducer should normally occupy the left gland.
- The right gland is used for power supply connection
- Whereas the centre ones are used for any interface signals connected.
-

Power supply may be either 115V/230V AC and/or 24V DC. Power consumption is appx. 50 W at 24V, appx. 70W at 115/230V.

If the AC power system is 115 V, EML224 may be prepared for 115V AC by re-connecting the connectors J102, J103 as shown in Fig. 4.3.

This diagram also shows position of fuses for 115/230 V AC and 24 V DC. These fuses are normal 5 x 20 mm slow blow glass fuses.

Supply voltage	Fuse	Value
230 V AC supply	FS100, FS101	0.5 A
115 V AC supply	FS100, FS101	1.0 A
24 V DC supply	FS102	3.15 A

When the installation is complete, and power is connected to the operator unit, the appropriate power switch by the power terminals is switched on. For daily operation, these switches may stay on and the unit is switched off by pressing the “SYSTEM off” button on screen A or screen B. The unit is switched on by pressing any button.

Both 115/230 V AC and 24 V DC power may be connected and switched on at the same time. If one of these supplies shuts down, changeover is automatic.

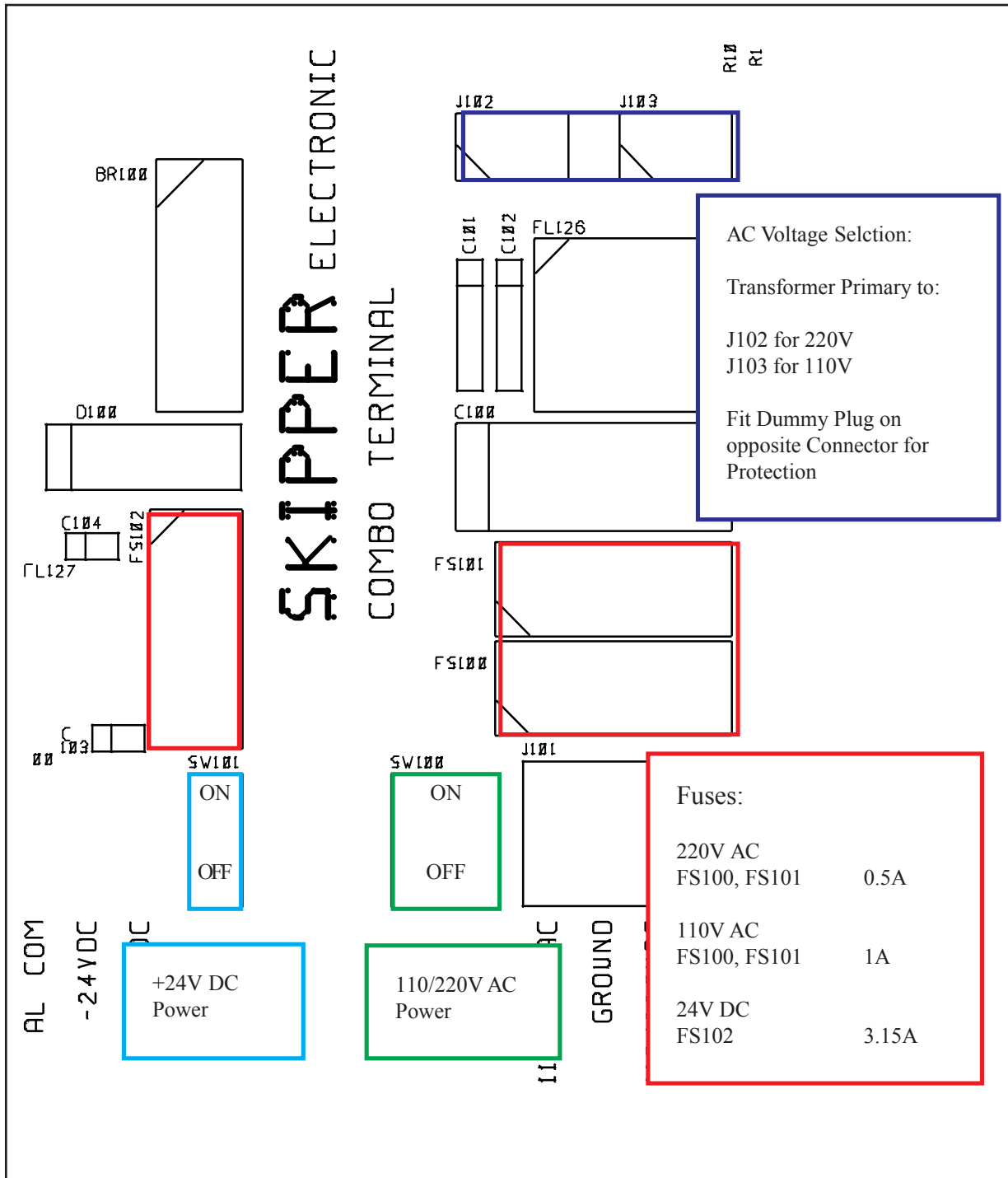

Fig. 4.3. Voltage selection connectors and fuses, Terminal Board, EML224 Operator Unit.

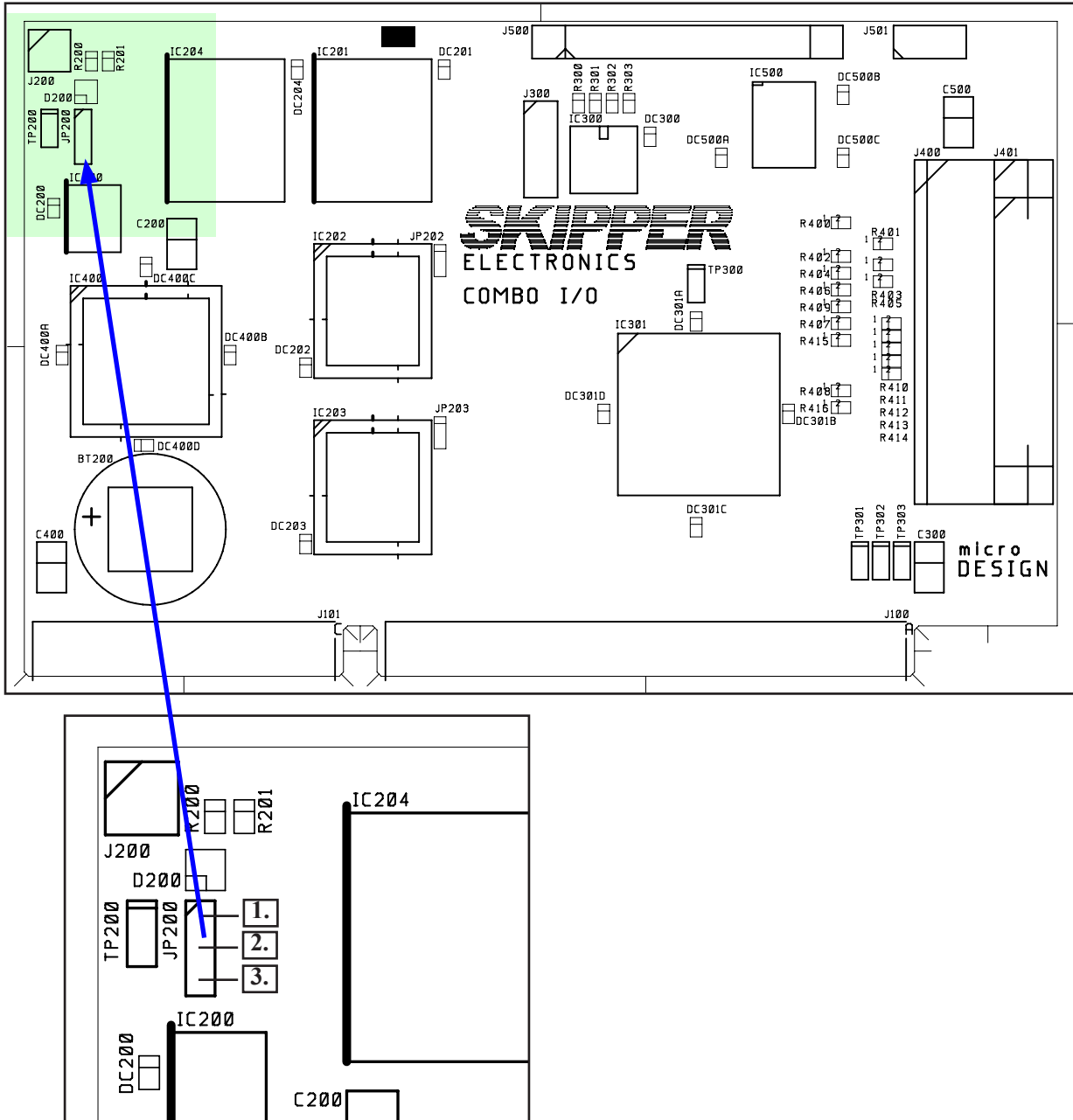

Fig. 4.4. Back-up Battery Jumper, I/O Board.

Back-up Battery Jumper JP200

After installation is complete and system power is applied, it is necessary to connect the battery to provide power to the circuitry containing user parameters at a system power failure. Refer to Fig. 4.4 for the correct setting of the battery jumper “ON” position 2-3. This jumper should be set to the “OFF” position 1-2 only during extended unit storage periods. The battery is active only when no power is applied to the power terminals.

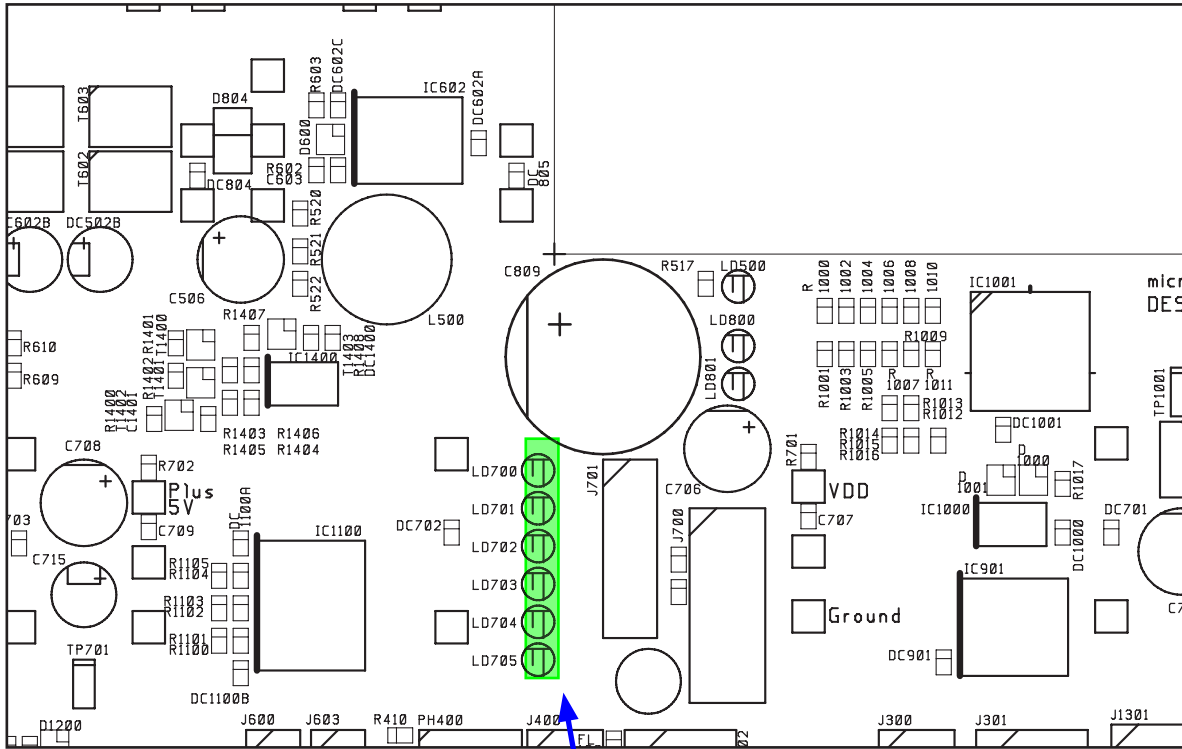

Fig. 4.5. Function LEDs, Terminal Board.

Power indication and function LEDs

The following LEDs are located on the terminal board:

LD700	+5 V#1/VCC (Board external and CPU)
LD701	+12 V#1/VDD (Board external)
LD702	+5 V#2 (Board internal)
LD703	+12 V#2 (Board internal)
LD704	-12 V
LD705	-5 V

Interfacing.

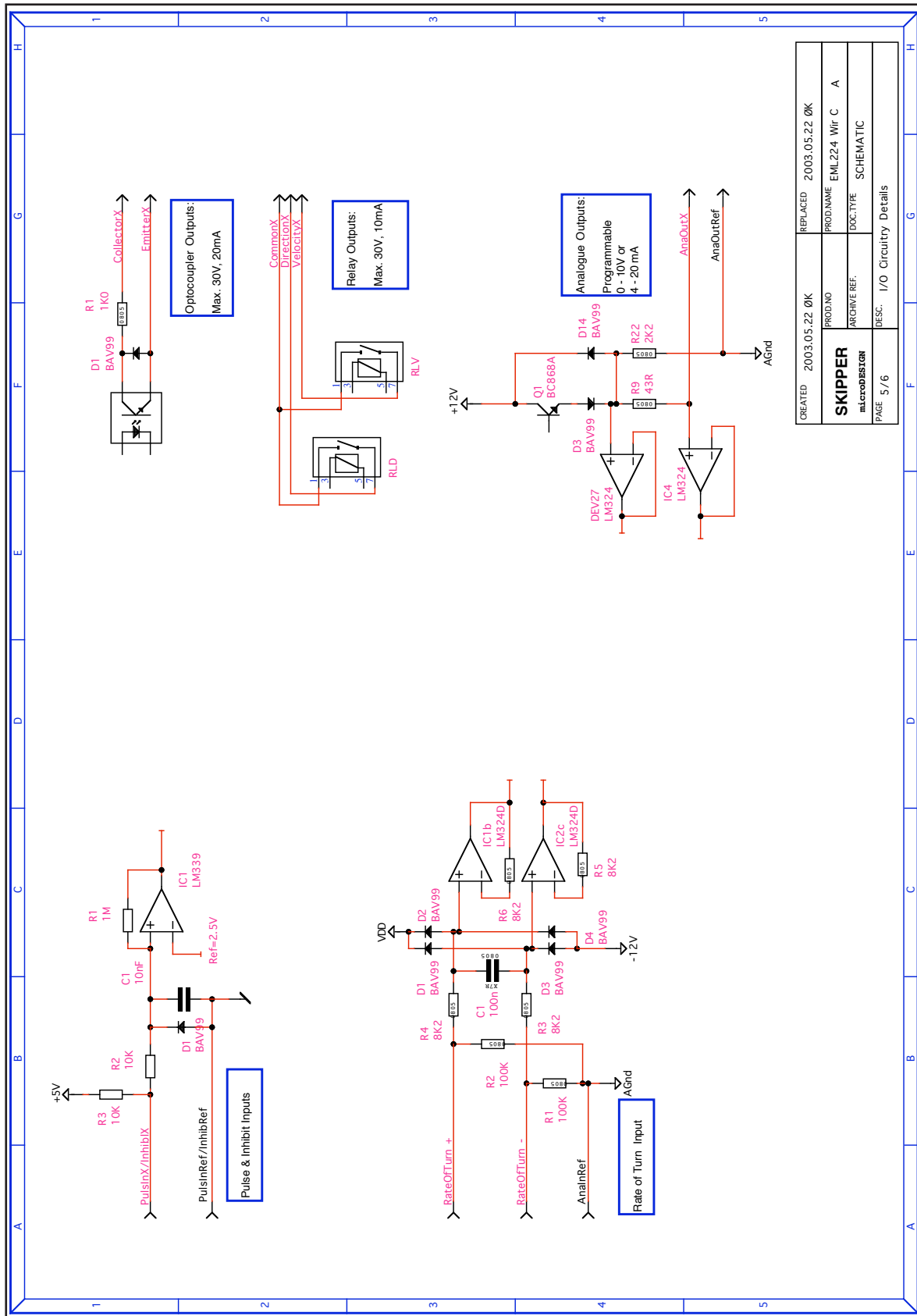

Fig. 4.6. Input/Output Circuitry.

Interfacing

Alarm Relay

An alarm relay is provided for interconnection to external alarm systems. This relay is normally energized, and is released by alarm conditions or power failure/power off. See appendix for drawing. The terminals have the following significance:

Name	J100 pin no	Description
ALCOM	3	Common terminal.
ALNO	4	Normally open contact
ALNC	5	Normally closed contact (Normal = "No alarm" condition)
INHIBREF	9	Reference for remote alarm reset
INHIB2	11	Remote alarm reset

Log Pulse Outputs

Pulse output terminals are as follows.

- Each group of pulse outputs are galvanically separated. All pulse outputs are opto coupled.
- The opto couplers may be used for any pulse rate.
- The pulse rates and velocity vectors to output are programmable in Status Screen, menu 3
- Possible settings are 10/100/200/400/1000 (1000 on Ch 3 only).

Name	J100 pin no	Description
OPT3DC	21	Optocoupler 3, direction collector.
OPT3VC	20	Optocoupler 3, velocity collector.
OPT3EE	19	Optocoupler 3, common emitters.
OPT2DC	18	Optocoupler 2, direction collector.
OPT2VC	17	Optocoupler 2, velocity collector.
OPT2EE	16	Optocoupler 2, common emitters.
OPTVE	15	Optocoupler 1, velocity emitter.
OPTVC	14	Optocoupler 1, velocity collector.

Opto coupler direction output, Transistor Off = AHEAD or STARBOARD

Analogue Interfaces

EML224 is equipped with 3 analogue outputs to supply analogue repeaters or other equipment with analogue inputs. The signals are galvanically connected to the EML224. Standard range is 0 - 10 V or 4 - 20 mA. The velocity vectors and output modes are programmable from status screen, menu 5:

Name	J100 pin no	Description
ANAOUTREF	22	System ground, common negative reference for analogue outputs
ANAOUT1	23	Analogue output #1
ANAOUT2	24	Analogue output #2
ANAOUT3	25	Analogue output #3

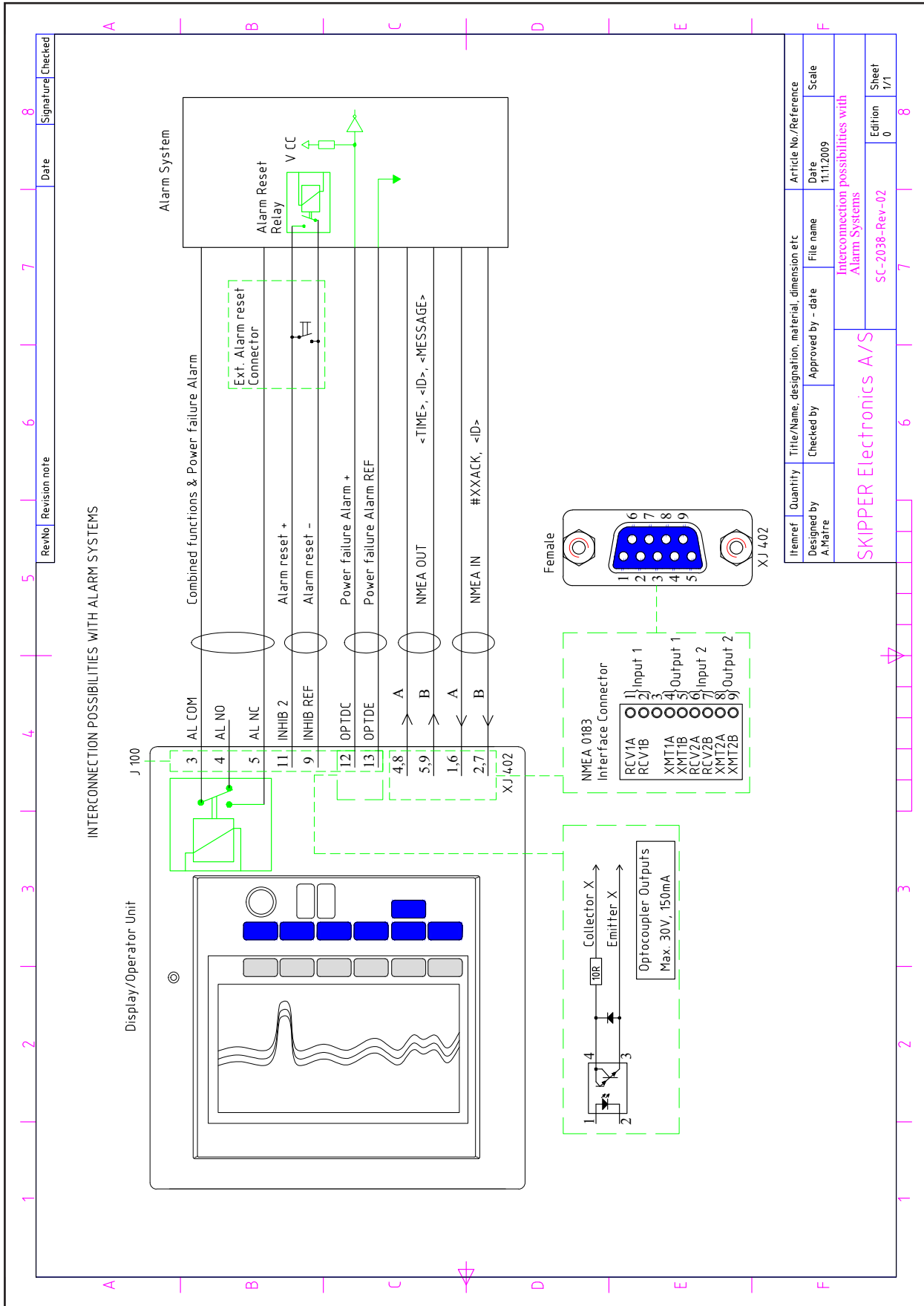

Fig. 4.7. Alarm interconnection

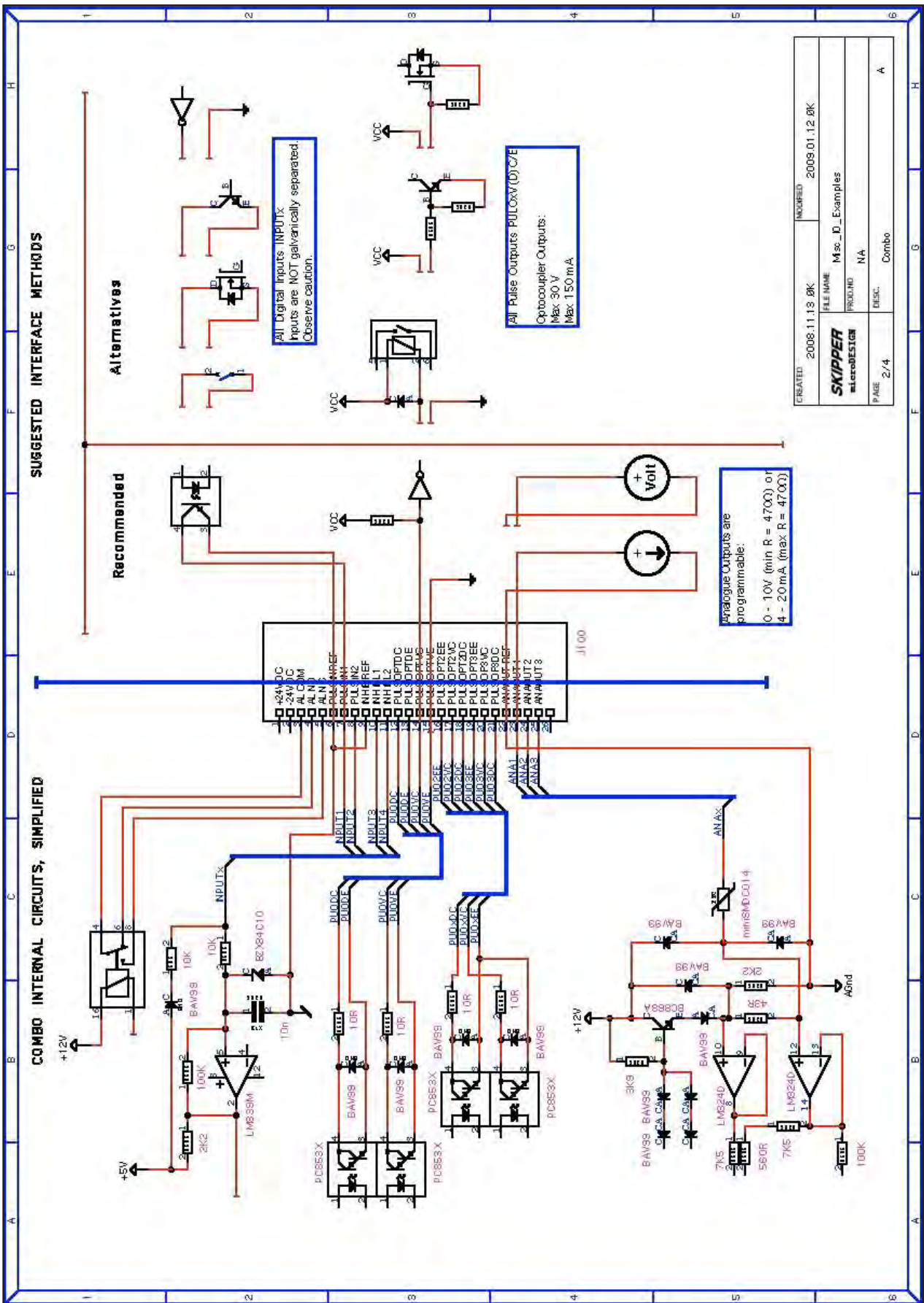

Fig. 4.8. Misc IO examples

NMEA interface

The NMEA outputs provides NMEA 0183 format speed information for other equipment with NMEA 0183 inputs. Standard COM settings is 4800 baud, 8 bit, no parity. Several messages may be selected on COM Screen and the enabled messages are transmitted every second.

The NMEA inputs accept position, heading and UTC time messages from various talkers. The two inputs provided may be connected to different talkers, and both data streams will be received. There are two outputs that each will drive up to 10 standard NMEA 0183 listeners.

See chapter 5 “Start-up and system adaption”, for a complete list of transmitted and received messages.

Also see fig. 5.1 for pin connections on external NMEA connector XJ402.

Options

Repeaters

- Analogue or digital speed and distance repeaters may be connected.
- SKIPPER IR300 speed, and/or SKIPPER CDLR distance repeater may also be connected.
- Interface NMEA 0183.

External Interface Ports

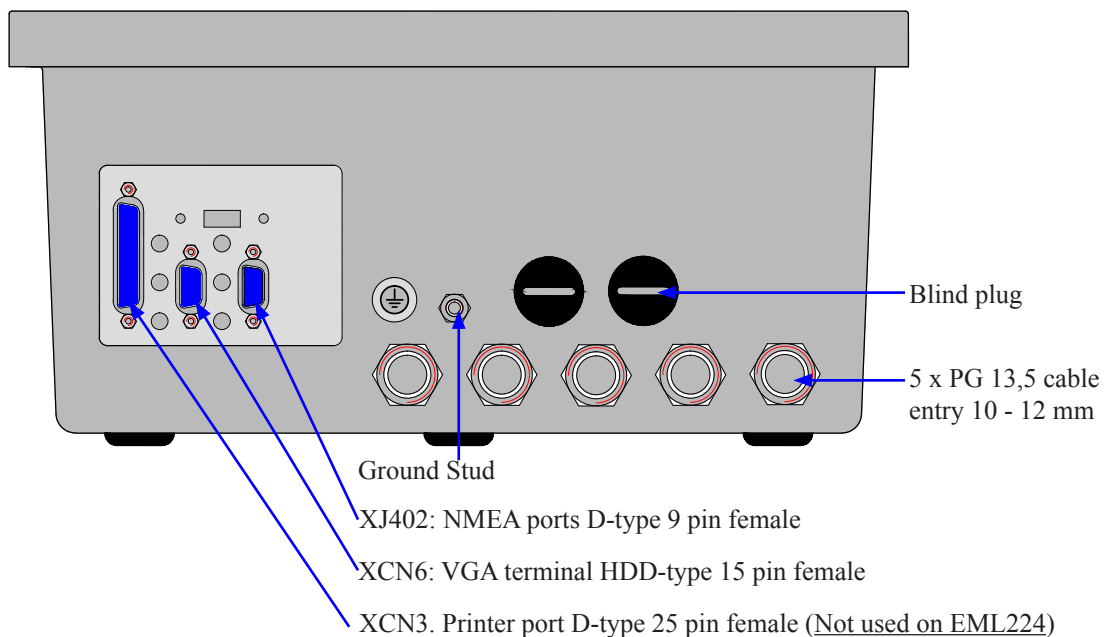

Fig. 4.9 External Interface Ports

5. Start-up and system adaption

Analogue Outputs and Log Pulse Outputs Range Selection

From Status Screen menu 2, it is possible to set number of pulses per nautical mile (p.p.n.m.) for the 3 available contact closure output channels (Ch) :

Channel number	Pulses per nautical mile
1	10, 100, 200 or 400.
2	10, 100, 200 or 400.
3	10, 100, 200, 400 or 1000.

(The selected value for each output is shown in status screen).

Minimum and max limits for the analogue outputs may be set to:

- Maximum speed -30/+30 knots corresponding to 10 V or 20 mA.
- Minimum speed -30/+30 knots corresponding to 0 V or 4 mA.

Language and Units of Measure

From status screen menu 4 it is possible to select different languages and units of measure for the screen and printer character strings.

The available languages are:

- English, French, Spanish, Russian, German and Norwegian.

Units of measure may be selected for:

- Vessel Speed: knots, km/h, miles/h, m/s.
- ES Range: meters, feet, fathoms, braccias.
- Distance: nm, km, miles.

NMEA Setup

Com screen is used for verification of received and control of transmitted NMEA messages. The baud rate may be set to 4800 or 9600, 4800 being the more common. When a NMEA talker is connected to one of the EML224 inputs, all received messages will be displayed on the screen. If no messages are displayed, check the signal polarity and the baud-rate. The following messages are accepted for input to EML224 and interpreted by the program. The talker identifier is ignored:

Time

Universal Time	ZZU,xxxxxx
Universal Time & Local	ZLZ,xxxxxx,xxxxxx,-xx
Day, Month, Year	ZDA,xxxxxx,xx,xx,xxxx,-xx

Position

Geographical Lat/Lon	GLL,xxxx.xx,N,xxxxx.xx,W
Geographical Fix, present	GXP,xxxxxx,xxxx.xx,N,xxxx.xx,W,cccc,x
Omega Fix, present	GOP,xxxxxx,xxxx.xx,N,xxxx.xx,W,cccc
Loran C Fix, present	GLP,xxxxxx,xxxx.xx,N,xxxx.xx,W,cccc
GPS Position	GGA,xxxxxx,xxxx.xxx,N,xxxxx.xxx,W,x

Heading

Heading, true, present	HDT,xxx.,T
Heading, magnetic, present	HDM,xxx.,M
True heading and status	THS,x.x,a*hh<CR><LF>
Heading, compass	HCC,xxx.

Composite

Loran C specific	RMA,a,xxxx.xx,N,xxxxx.xx,W,,xx.x,xxx.,*xx
GPS, Transit specific	RMC,xxxxxx,a,xxxx.xx,N,xxxxx.xx,W,xx.x,xxx.,xxxxxx.,*xx
Vessel Identification	IMA,aaaaaaaaaa,aaaxxxx,xxxx.xx,N,xxxxx.xx,W,xxx.x,T,xxx.,M,xx.x,N

EML224 transmitted (originated) NMEA 0183 messages

VHW	Boat Speed and Heading	\$VDVHW,,,,,x.x,N,x.x,K*hh<CR><LF>
VLW	Distance Travelled through the water	\$VDVLW,x.x,N,x.x,N*hh<CR><LF>
VLW IEC07	Dual ground/water distance	\$VDVLW,x.x,N,x.x,N,x.x,N,x.x,N*hh<CR><LF>
VBW	Dual ground/water speed	\$VDVBW,x.x,x.x,A,x.x,x.x,A,x.x,A,x.x,A*hh<CR><LF>
MTW	Temperature	\$VDMTW,x.x,C,*hh<CR><LF>

All data fields are free format. Values will be preceded with sign as needed (e.g “-“ = Astern, Port)
 *hh = Checksum

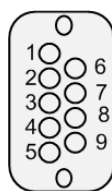

NMEA IN: Pin 1-2, RCV1 A, B
 NMEA IN: Pin 6-7, RCV2 A, B
 NMEA OUT: Pin 4-5, XMT1 A, B
 NMEA OUT: Pin 8-9, XMT2 A, B

Fig. 5.1 9 Pin D-Type NMEA connector XJ402 in cabinet front (seen from outside).

6. Calibration procedure

Speed logs are calibrated in the factory to give reasonable results after installation, however installation and hydrodynamics vary from vessel to vessel. It is therefore necessary to calibrate speed logs once in place.

SKIPPER speed logs have two parameters that need to be corrected by calibration.

1. Angular sensor installation error (heading error).
2. Speed variations due to drag or mounting tilt.

1. Heading Error



The heading error parameter corrects for an angular offset in mounting. This offset will result in a rotation of the measurement axes. The resultant speed will be unaffected, but the longitudinal and transversal components will be incorrect. An offset will result in the vessel typically showing too much transversal speed, but may also result in speed calibration failing (i.e. initial calibration fails when further points are added). This offset will show itself as an averaged drift on the calibration.

Reducing Heading errors. New generation sea valves can be manually adjusted to ensure the sensor is correctly aligned. Alignment and heading offset are directly connected. To minimise the offset, the sensor should be mounted pointing ahead

- **Tank mountings** have ahead marks on both the tank and the sensor insert.
 - **Sea valves** have either a mark on the top flange (DL850 540 retro fit system) or a flat mark on the port side of the pole which when a flat object is placed against this, will point fore/aft (Figure 6.1).
2. **Speed variations** due to drag or mounting tilt.

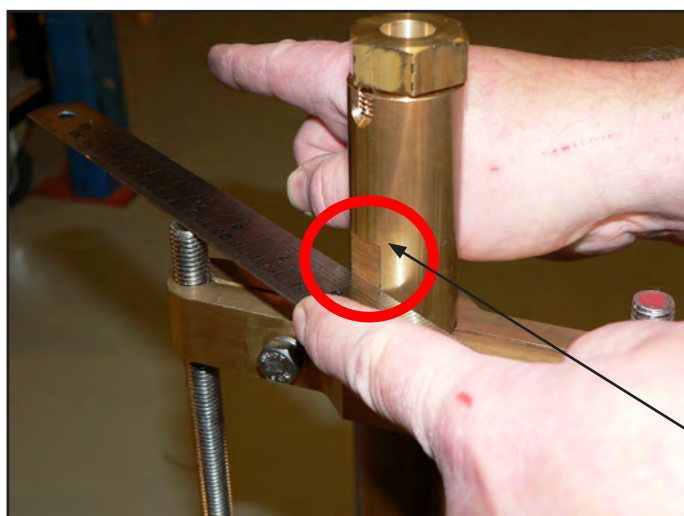

A flat object points fore/aft.

Figure 6.1 Sea valve alignment

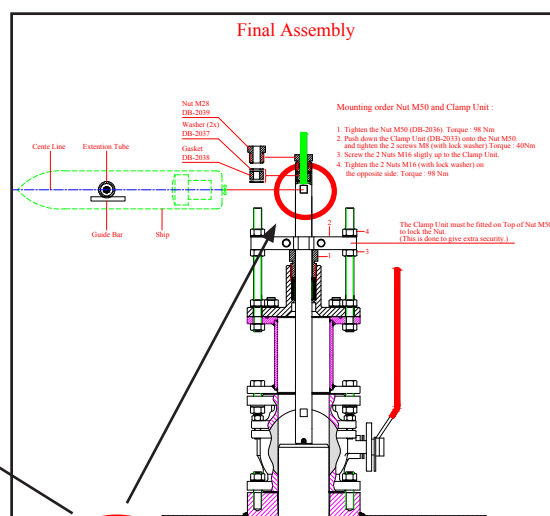

The flat side should be on the port side.

Every vessel will drag some water when it moves. This occurs over the whole hull. As you move further from the hull, the effect of the ships movement gets less. As the vessel moves at different speeds, the hydrodynamics of the vessel may change. In most cases the drag is even over the whole range of the vessel.

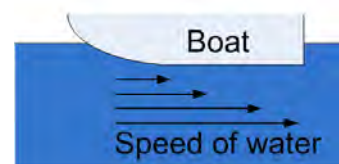

Speed logs that measure on the surface of the vessel (such as EML) are more affected by this factor than sensors that measure remotely (Doppler). The calibration variation is usually less on remote sensors.

As the calibration factors can vary at different vessel speeds, it is possible to calibrate several speeds. It is typically necessary with only one high and one low speed. Speed logs with speed over ground can be compared with GPS speed over ground in stable conditions. However speed through water measures the influence of currents on the vessel, which cannot normally be measured on any other system. It is therefore important that full calibration is performed at least once for speed through water.

Calibration routine:

As previously explained, there are two factors to be calibrated, heading error and speed. Speed over ground can be calibrated in two ways. Speed through water can be approximated, but should be calibrated by sailing on opposite courses to get an accurate value.

All calibration functions are located on the **Calibration** screen. In order to select this screen, press “screen select” button in the lower row of the panel buttons and while keeping it pressed, turn encoder until desired screen appears on the display.

Activation of the hidden menus

To avoid accidental access to the internal settings, all calibration functions are disabled during normal operation. In order to activate them, do the following:

- Open front door of the cabinet and find a “hidden” key on the component side of the keyboard PCB (upper/left corner of the PCB).
- Press key mentioned above and keep it pressed for 2-3 seconds, until “Calibration on” message is observed in the right/upper corner of the screen. The text on the soft keys will change colour from grey to white, which indicates availability of the corresponding functions.

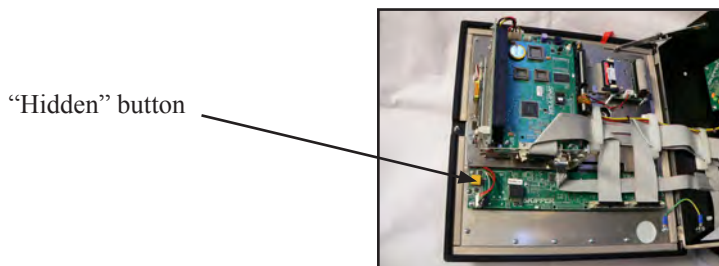

Note: After calibration is finished, disable access to the calibration functions simply by pressing the key again. Calibration mode is also disabled after a power recycling.

Step 1. Heading error correction:

The vessel sails a steady course in calm waters and the user reads the resultant angle (averaged drift). This is entered into the system using the **Head err** button and encoder on menu 3, and adjusted until the **averaged drift** angle is zero.

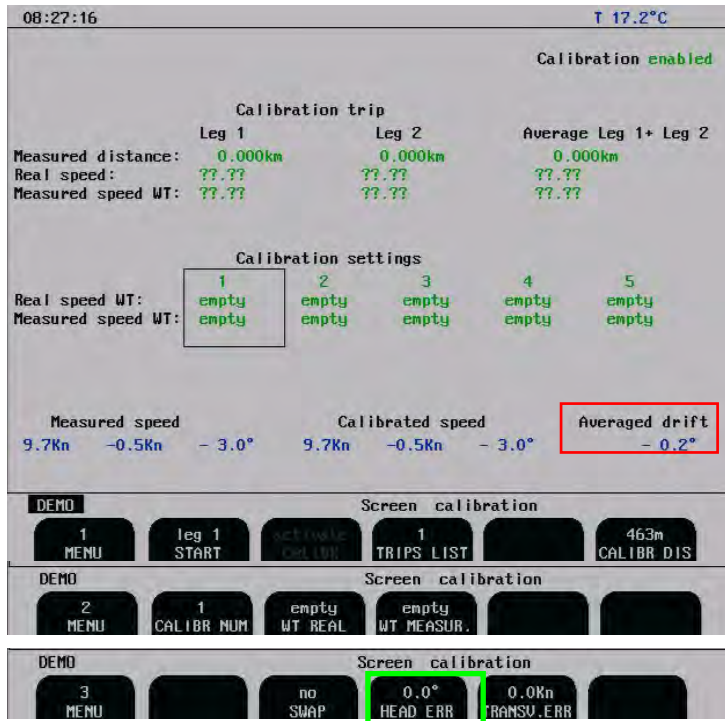

Step 2a. Manual speed calibration/adjustment:

The user enters speed values directly into the calibration table by comparing to other equipment, such as GPS. This can also be used to adjust values. Menu 2 allows you to enter the values directly. Press and hold an empty button will take the current values and place them in the table.

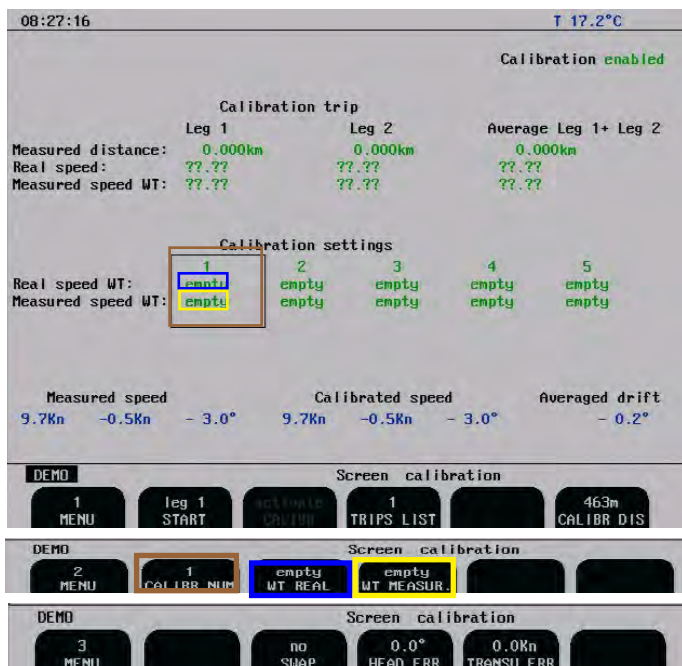

Screen calibration showing manual adjustment.

Placing values in the WT (Water Track) is not accurate, as it does not take water currents into account. (Step 2b is recommended).

Step 2b. Semi Automatic calibration:

The vessel is made to sail a known distance and course in both directions, this to remove any water current factors from the speeds.

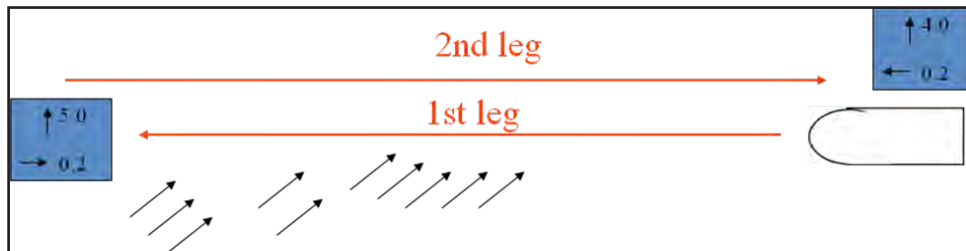

The 1st leg will show a different speed to the 2nd leg, however the direction changes in the second leg so that the average is correct.

The speed can be calibrated as follows:

1. Assuming you have performed step 1 “Heading Error”, plot a known distance on the chart. Enter this value into the **1.000NM CALIBR DIS** on menu 1.

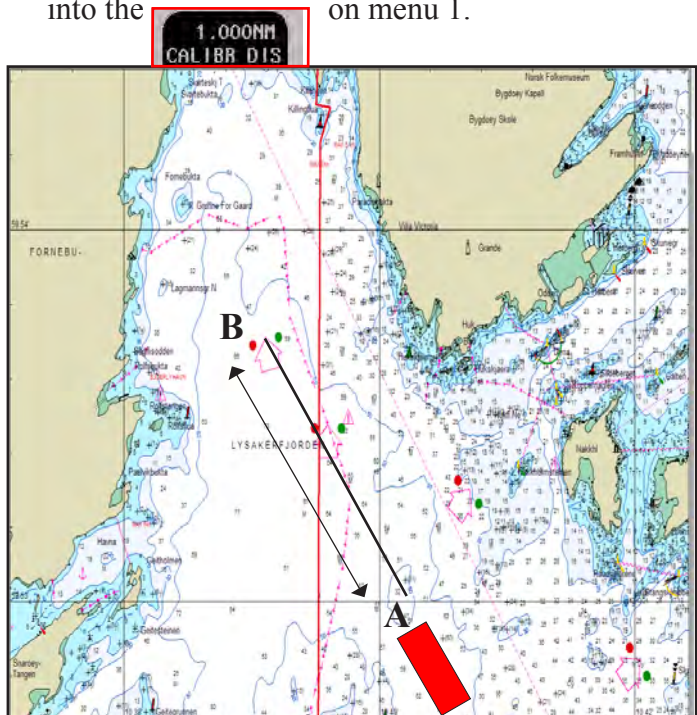
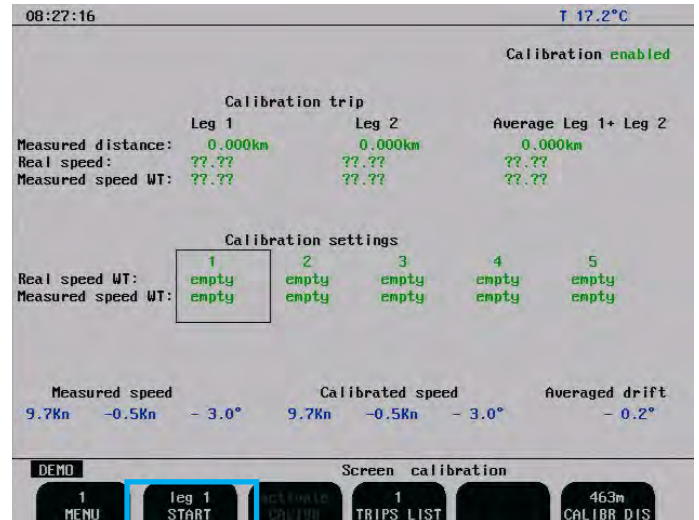
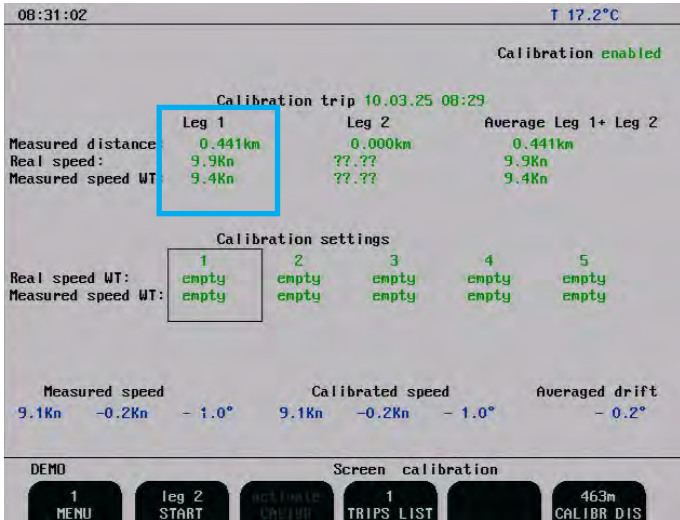

Figure shows plotting a calibration path on the chart.

The leg should take at least 5 minutes to sail (distance can be shorter when sailing slowly). Depth should be < 50 m to ensure that bottom track also calibrates correctly.

- Sail at a straight course in direction A to B and at a constant speed. When passing to point A, Press **START leg 1** on menu 1. The button text will change to stop and a calibrating warning will show on the screen.



- The **leg 1** measured distance will count up. You may ignore this. When you reach point B, press STOP. The system will then calculate the measured speed (from the measured distance and time) and the real speed (from the Calibr distance and time).
- Turn the vessel and repeat for leg 2 in the opposite

direction at the same speed. The results will show in the **Leg 2 table**. The average of the two legs will show in the final table. This is the correct calibration.

- If the calibration looks correct, you may select which calibration settings table to place it in, and transfer using the **activate calibr** button (which will be active if the calibration is within limits).

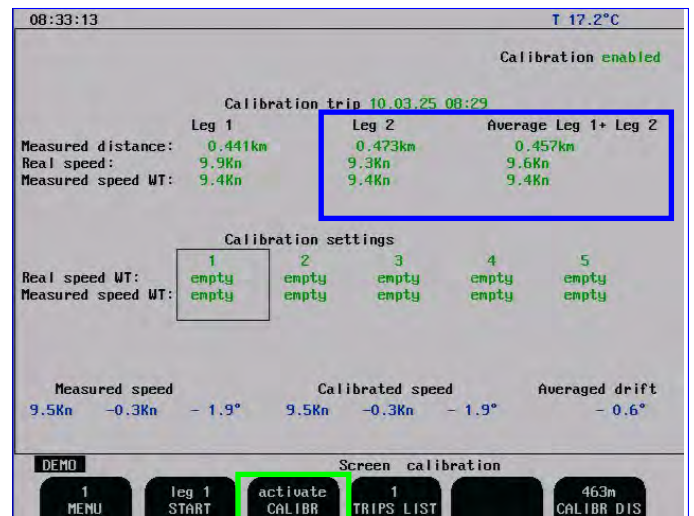
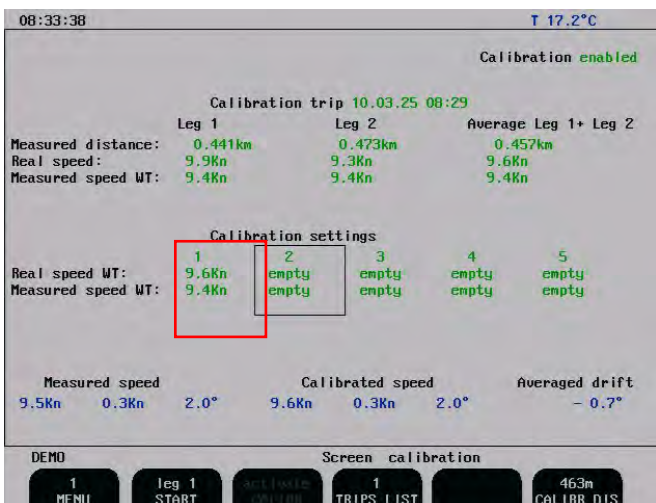

- You have now made a **calibration point**. We recommend a point at low speed (1-3 kn) and one at max speed (20 kn).
- Once calibrated, check the system at other speeds. If it is inaccurate, you may add more points (max 5).

NOTE: These values may be overwritten in some software upgrades or if master reset is performed. We advise recording the values somewhere, just in case. EML systems typically have a calibration factor of up to 50 % i.e. measured 5 kn, real 10 kn, depending on mounting position and hull design.

7. Specifications

Dimensions

Sensor		
	Cable length	40 m.
	Mounting	Sea valve or tank.
Electronic Unit	H x W x L	120 x 300 x300 mm.
	Weight	ca. 6 kg.
Operator unit cabinet	Height, front	340 mm.
	Width	320 mm.
	Depth	170 mm.
	Weight	ca. 10 kg.
Operator Unit Cabinet,		
	Cut-out for flush mounting	H x W
	Corner radius	4 mm
		322 x 302 mm.

Functional Properties

Display	10,4" 158 x 211 mm TFT LCD, 640 x 480 pixels.
Speed alarms	High and low limits.
Calendar/clock	Year-Month-Day / Hours-Minutes (24 hour system).
Interface outputs	Pulses for speed. Analogue 4 - 20 mA and 0 - 10 V for speed.
	NMEA 0183.
	Alarm relay.
	VGA output for external monitor.
Interface inputs	NMEA 0183 for position, heading and time.
Languages	English, French, Spanish, Russian, German and Norwegian.
Options	Digital speed and distance repeater.

Performance

Trip counter	Measurement from 0 to 99 999.99 nautical miles.
Distance accuracy	0.2 nm or 2 % whichever is greater.
Speed accuracy	0.2 Kn or 2 % whichever is greater.
Speed range	+/- 40 Kn.
Rolling	More than +/- 10 degrees.
Pitching	More than +/- 5 degrees.

The performance will depend on turbulence, aeration and sea conditions. These effects may lead to occasional incorrect indication of speed and distance. Speed measurement is done directly on the sensor surface, comply with IMO Res. A.824/A1.1

Environmental according to IEC60945

Operator/Display Unit		
	AC Supply voltage	230 V(195 - 253 V AC) or 115 V(96 - 125 V AC).
	DC supply voltage	24V DC (20-32 V).
	Power consumption	50 W at 24 V, 70 W at 230 V or 115 V.
	Alarm relay	Change-over contact, max. 24 V 300 mA.
	NMEA port	9 pin D-type. 2 inputs, 2 outputs.
	Operating temperature	-15 - 55 degree C. To increase serviceability and lifetime, we suggest the working temperature to be held at 0 - 40 degrees C.
	Storage temperature:	-20 - 70 degree C.
	Humidity	10 - 90 % relative, no condensation.
	Protection	IP 23.
Electronic Unit		
	AC Supply voltage	230 V(195 - 253 V AC) or 115 V(96 - 125 V AC).
	DC supply voltage	24V DC (20-32 V).
	Operating temperature	-15 - 55 degree C,.
	Storage temperature	-20 - 70 degree C.
	Protection	IP33.
Transducer (sensor)		
	Operating temperature	-15 - 55 degree C.
	Storage temperature	-20 - 70 degree C.
	Protection	Submerged, 6 bar.

8. Trouble Shooting

Symptom	Cause	Remedy
Basic System Integrity		
<ul style="list-style-type: none"> No picture on LCD screen. 	<ol style="list-style-type: none"> No AC or DC power to the system. System is in standby mode. Defective LCD module. Voltage(s) out of range. 	<ol style="list-style-type: none"> Check switches and fuses on the terminal board inside the EML224 cabinet. Press any button on the panel. Replace LCD module. Replace terminal PCB.
<ul style="list-style-type: none"> Picture is difficult to read. 	<ol style="list-style-type: none"> Backlight is too weak. 	<ol style="list-style-type: none"> Increase backlight settings.
<ul style="list-style-type: none"> Display backlight malfunctions. Display picture is hardly visible.. 	<ol style="list-style-type: none"> Error during initialization. Defective backlight tubes. Defective backlight power inverter. 	<ol style="list-style-type: none"> Turn off power and wait for 5 sec. before restart. Replace backlight tubes. Replace inverter PCB.
<ul style="list-style-type: none"> Rotary encoder malfunctions. 	<ol style="list-style-type: none"> Defective Encoder or interface. SW problem. 	<ol style="list-style-type: none"> Replace keyboard PCB. Recycle power.
<ul style="list-style-type: none"> Panel buttons malfunctions. 	<ol style="list-style-type: none"> Defective buttons or interface. One button stuck. SW problem. 	<ol style="list-style-type: none"> Replace keyboard PCB or I/O PCB. Check key switches or replace keyboard PCB. Recycle power.
<ul style="list-style-type: none"> Loose user setup and calibration data. 	<ol style="list-style-type: none"> Battery backup not enabled. Battery empty. 	<ol style="list-style-type: none"> See chapter for Jumper JP200 instructions. Replace battery or I/O board.
<ul style="list-style-type: none"> Ambient t in status screen shows too high. 	<ol style="list-style-type: none"> Obstructed air flow. Defective fan. 	<ol style="list-style-type: none"> Check installations for obstructions of vent holes. Replace fan.
<ul style="list-style-type: none"> Wrong main voltages, (Acceptable range) +5V CPU: (4.7V - 5.3 V) +5V IO: (4.7V - 5.3 V) +12V CPU: (11.3V - 12.7 V) +12V IO: (11.3V - 12.7 V) 	<ol style="list-style-type: none"> Defective power supply. CPU or I/O PCB problem. Terminal PCB problem. CPU problem. 	<ol style="list-style-type: none"> Replace terminal PCB. Replace CPU or I/O PCB. Replace terminal PCB. Replace CPU.

Symptom	Cause	Remedy
Installation problems		
<ul style="list-style-type: none"> Screen COM RX status shows Link: No signal. In Electronic Unit: LD100 is not active. 	<ol style="list-style-type: none"> Electronic Unit power is off. Incorrect supply voltage. 	<ol style="list-style-type: none"> Switch on the power of the transceiver unit or check fuses. Check supply voltage.
<ul style="list-style-type: none"> Screen COM RX status shows Link: No signal. In Electronic Unit: LD100 is active, LD200 is not active 	<ol style="list-style-type: none"> No power to sensor. Bad connection of the sensor cable. Defective sensor or cable. 	<ol style="list-style-type: none"> Check voltage terminal 1 and 2 on J200. Should be 24V. Check if the sensor is connected on the Electronic Unit terminal according to wiring diagram. Test/replace sensor.
<ul style="list-style-type: none"> Screen COM RX status shows Link: No signal. In Electronic Unit: LD100 is active, LD200 is active 	<ol style="list-style-type: none"> No data from sensor. Com port locking due to “fiddling work” on serial lines. 	<ol style="list-style-type: none"> Sensor must be reconfigured or replaced. Recycle power.
<ul style="list-style-type: none"> Screen COM RX status shows Link: Data error. 	<ol style="list-style-type: none"> Wrong polarity on serial line from sensor. Wrong polarity on serial line between Electronic Unit and display unit. Damaged communication cable. 	<ol style="list-style-type: none"> Check connection and polarity of the serial lines. Check connection and polarity of the serial lines. Test / replace cable
Interface problems		
<ul style="list-style-type: none"> NMEA input signals are not listed in the NMEA input screen. 	<ol style="list-style-type: none"> Wrong polarity of input signals. 	<ol style="list-style-type: none"> Swap NMEA0183 input lines.
<ul style="list-style-type: none"> NMEA input signals are listed in the NMEA input screen, but not accepted by the EML. 	<ol style="list-style-type: none"> Error during initialization. Irregular message mnemonic. 	<ol style="list-style-type: none"> Cycle power of operator unit after NMEA Connection is established. Check remote (talker) setup.
<ul style="list-style-type: none"> NMEA output signals are not accepted by the remote system. 	<ol style="list-style-type: none"> Remote (listener) setup. 	<ol style="list-style-type: none"> Verify correct remote (listener) setup.
<ul style="list-style-type: none"> Analogue output malfunctions. 	<ol style="list-style-type: none"> Incorrect range settings. 	<ol style="list-style-type: none"> Verify upper and lower limits in status screen.
<ul style="list-style-type: none"> Pulse output malfunctions. 	<ol style="list-style-type: none"> Incorrect pulse frequency settings. 	<ol style="list-style-type: none"> Verify pulse settings in status screen.
<ul style="list-style-type: none"> Alarm output do not work. 	<ol style="list-style-type: none"> Incorrect terminal. Defective output. 	<ol style="list-style-type: none"> Check use of ALNC and ALNO terminals. Replace terminal PCB.
Basic functionality		
<ul style="list-style-type: none"> Constantly wrong speeds or no speed. 	<ol style="list-style-type: none"> Wrong calibration. Growth on sensor. Damaged sensor. 	<ol style="list-style-type: none"> Check calibration/recalibrate. Clean sensor. Replace sensor.

Typical Status Screen Contents

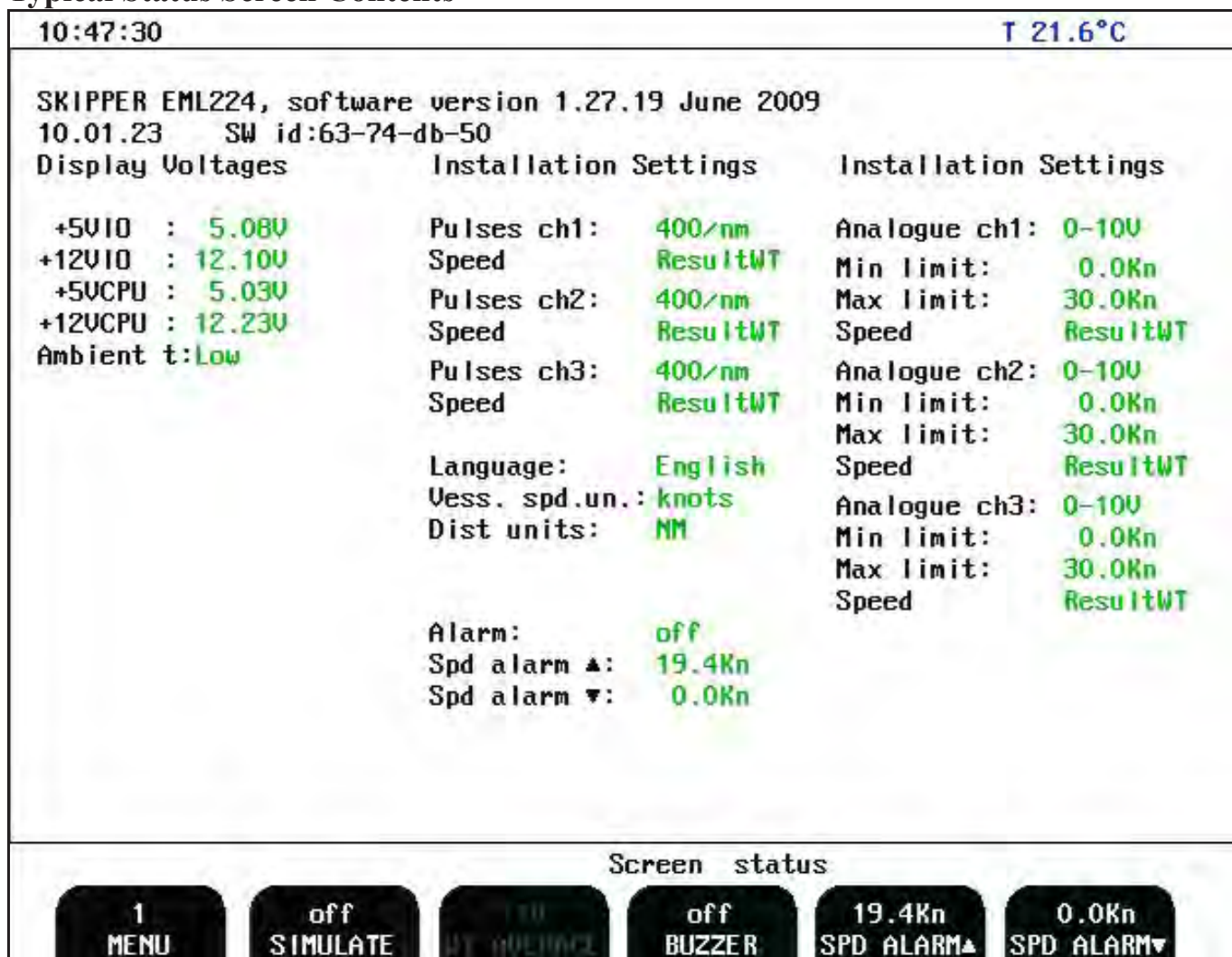

Fig. 8.1 Typical contents of status screen

The Status Screen contain information that will facilitate analysis and correction of several problems. Information from the status screen should be sent by fax/E-mail with any report about functional disturbances. This will greatly facilitate remote failure analysis. If it is possible to cycle through the screens and observe this information, several assumptions may be made regarding operation of the EML224 system. Although some of the subsystems necessary for this basic system operation may still suffer from minor or intermittent operation disorders, the fact that it is possible to select and observe this screen, indicate correct operation of the following EML224 subsystems:

- The CPU board is operating.
- The keyboard interface board with backlight and LCD power supplies is working.
- The keyboard interface part of the I/O board is working.
- The power supplies on the terminal board are basically working.

The other information on the status screen is a collection of information which may be observed and manipulated with the various screen softkey selections. As a reference, it will often be more convenient to observe the various settings together on this screen than to cycle from screen to screen to check on the softkey texts.

9. CPU Board Setup Procedure

CPU PCA 6742VE

(Bios version 1.12). The PCA 6742 has the default settings with the following changes. Start by loading the optimized defaults, and then change the following:

STANDARD CMOS FEATURES

- Date: Change to todays date
- Time: Change to time now
- Halt on: No errors

Advanced BIOS Features

- a. Hard Disk priority [Press enter] – Press enter
 - i. 1 should be ch.1 M.
 - ii.2 should be ch 0 M.
- b. First Boot Device[Hard Disk]
- c. Second Boot Device [Hard Disk]
- d. Boot other device [Disabled]

Advanced Chipset features

- a. SMI712 VGA Settings [Press Enter] – Press enter
 - i. SMI712 VGA Monitor [Simul monitor]
 - ii. Panel resolution Mode [640x480 TFT]
- b. USB Device Setting [Press Enter] – press enter
 - i. USB1.0 emulation [Disabled]

Integral Peripherals

- a. Onboard serial Port 3 [enter]
 - i. Change to [2E8/IRQ9]
- b. Onboard serial Port 4 [enter]
 - i. Change to [3E8/IRQ5]
- c. Parallel Port Mode [EPP]
- d. EPP Mode Select [EPP1.9]

PnP/PCI Configurations

- a. Resources Controlled By [Manual]
- b. IRQ Resources [Enter]
 - i. IRQ – 7 assigned to [Legacy ISA]
 - ii. IRQ – 10 assigned to [Legacy ISA]
 - iii. IRQ – 11 assigned to [Legacy ISA]
- c. NO DMA

PC Health Status

- a. Case Open Warning [Disabled]

SAVE SETTINGS AND EXIT

Master Reset Procedure

After completed setup procedure, you should always do a “MASTER RESET”:

- Switch off the EML224, using the internal toggle switch(es) and wait a few seconds.
- Then press down and keep pressed the softkey to the far right and far left (no. 1 and 6) in the upper row on the EML224 keyboard.
- Turn the EML224 ‘on’ and keep the two softkeys pressed down until the screen shows the normal picture. This may take as long as app. 30 seconds. You should normally hear 4 “beeps” at the end of the procedure.

Upgrading Software

New software versions are released from time to time. The EML224 with Compact Flash (CF) can be updated by performing the following software upgrade procedure.

1. If you have received a programmed compact flash, skip stage 2.
2. Copy the received/downloaded software file into the root folder of Compact Flash card. The name of the file is not relevant. Also copy the latest version of setup.exe into the root folder .

Note: Standard Compact Flash reader is needed to be attached to the PC.

Note: It is possible to use the Compact Flash card, which is already installed in the display unit.

3. Switch OFF the mains of the display unit and insert Compact Flash card with the new software on it.
4. Press the “hidden” button inside the cabinet (mounted on the solder side of the keyboard). Keeping the hidden button pressed, switch ON the mains in the display unit and keep the button pressed while the message “You may release the hidden button” appears in the lower part of the screen. If a new setup.exe is to be loaded, follow the on screen instructions.
5. Release the hidden button. After few diagnostic text messages, the list of available software versions will appear in the lower part of the screen as in example below.
6. Note: If the bootloader does not find any file with the software on the Compact Flash, the presently installed version will start automatically. In this case, make sure, that the upgrade and setup file has been copied correctly on the Compact Flash and repeat procedure.

1.27.12	1.27.19				
Active	External				



7. Select a software version, which you would like to install. Normally, it is possible to chose one out of two: the version, which is currently installed in the internal memory (indicated as Active) and the upgrade version (indicated as External). The version name is displayed in the upper line of the text lines, located just above the corresponding softkey. In the example above, soft key #2 should be pressed to select the latest software version.
8. Confirm selection by pressing YES button (or go back to selection, pressing NO).
9. Press any button to start the upgraded software (or it will start automatically in 5 seconds).
10. Note: The file with a previous software version will be copied back to the Compact Flash card, so it would be possible to re-install it in the similar manner, if desired.

10. Service

All service requests should be made to the local SKIPPER representative.

Adjustments and repairs should only be performed by qualified service engineers, and unqualified repair attempts will void the warranty.

11. Appendix

Miscellaneous Installation Drawings.

- Fig. 11.1 EML224 System overview
- Fig. 11.2 Terminal board connection
- Fig. 11.3 Outline dimensions display unit
- Fig. 11.4 Outline dimensions electronic unit

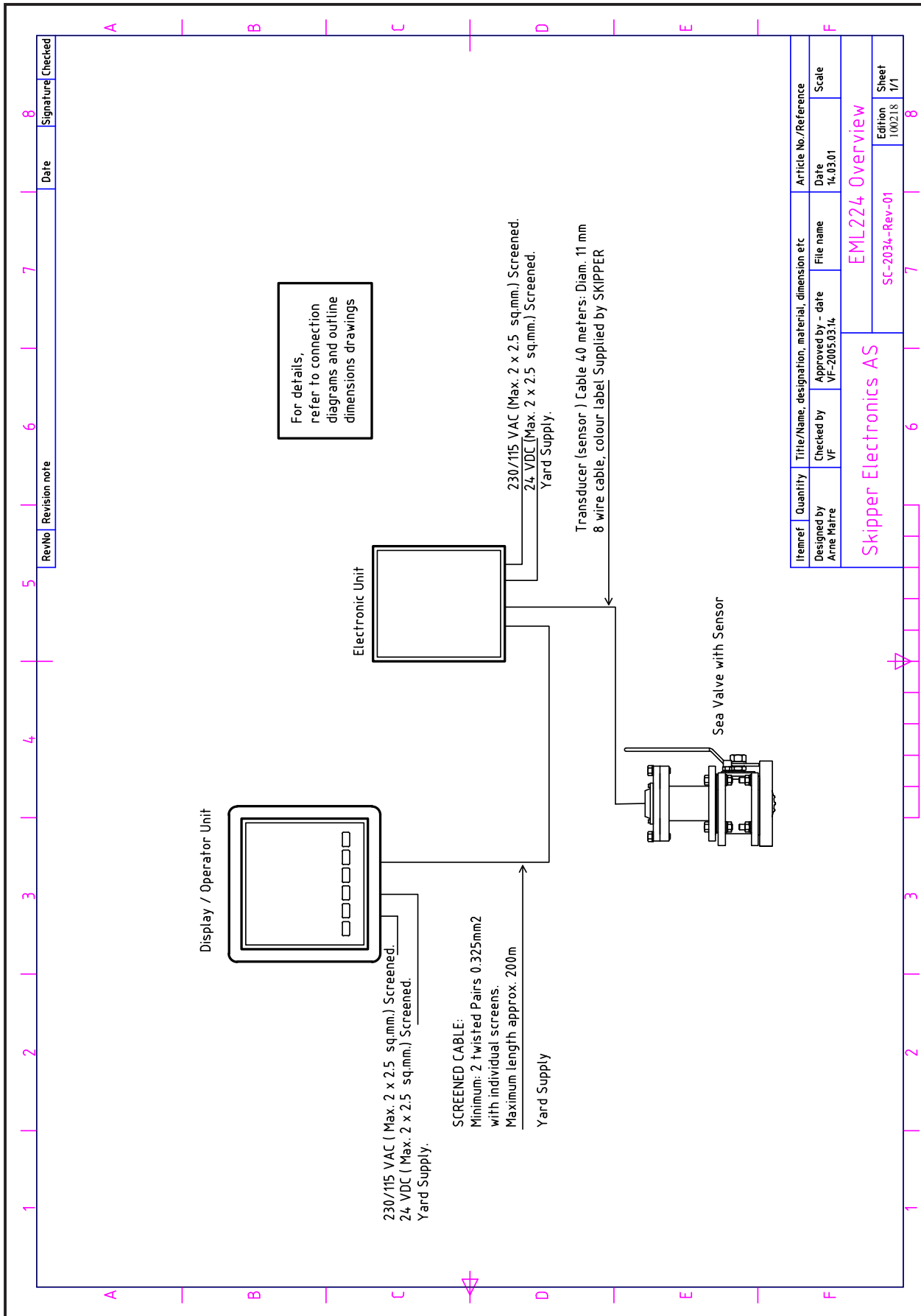

Fig. 11.1. EML224 System overview

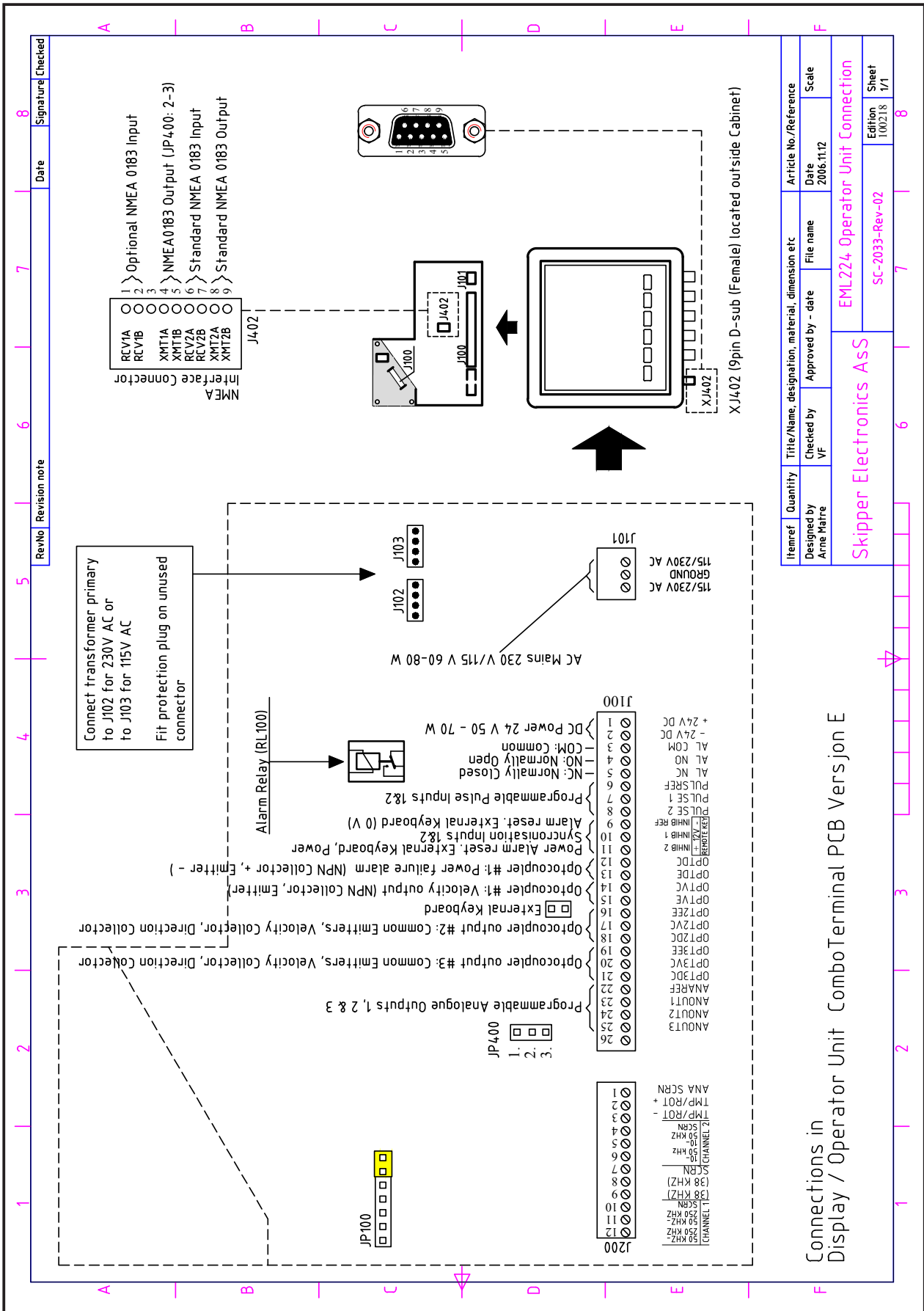

Fig. 11.2. Terminal board connections

Itemref	Quantity	Title/Name, designation, material, dimension etc	Article No./Reference
Designed by	Arne Mairre	Checked by	VF
Approved by - date		File name	2006.112
Scale		Date	2006.112
EML224 Operator Unit Connection			
Skipper Electronics AS			Sheet 1/1
SC-2033-Rev-02			Edition 100218

Connections in Display / Operator Unit Combo Terminal PCB Version E

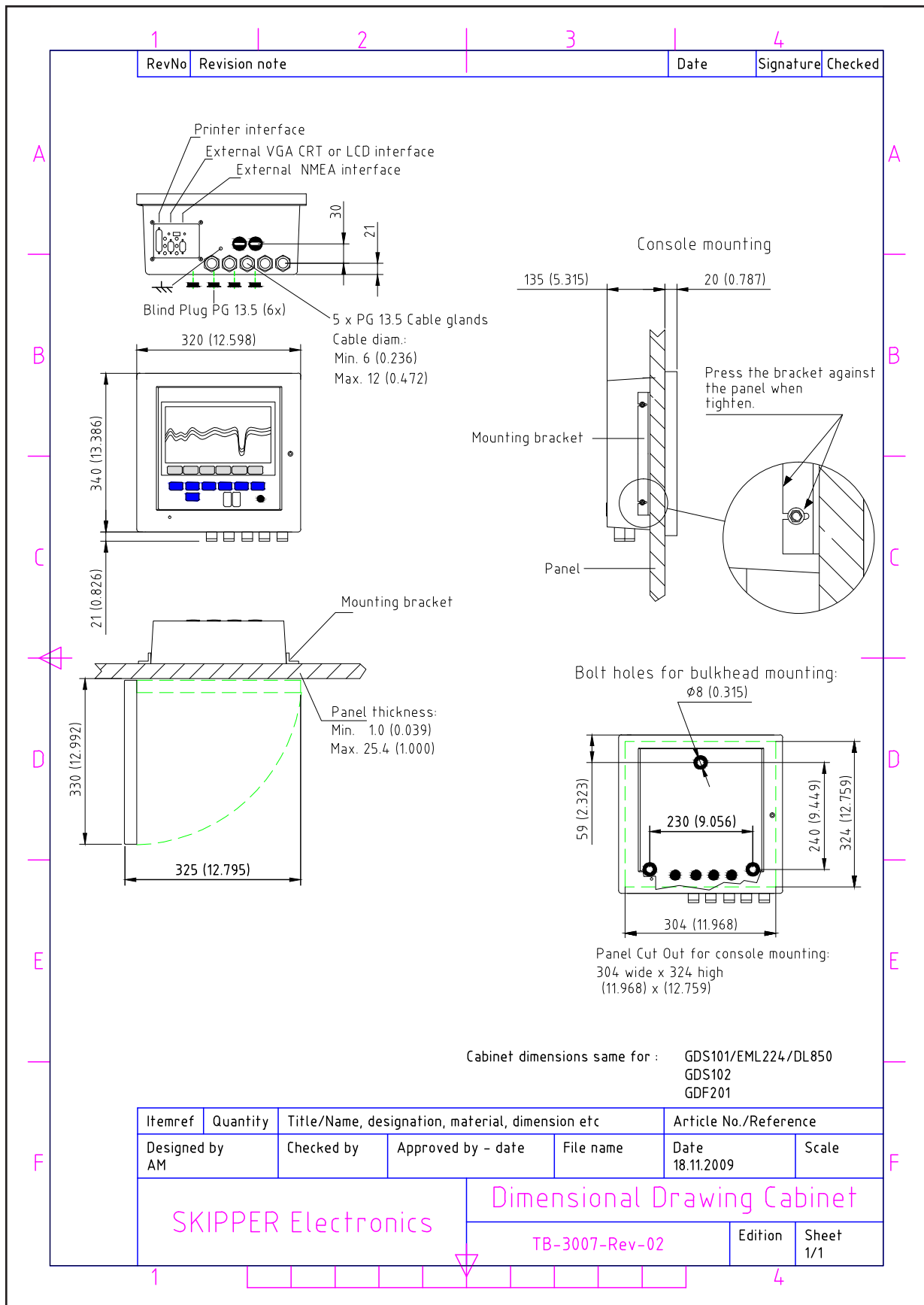

Fig. 11.3 Outline dimensions Display Unit

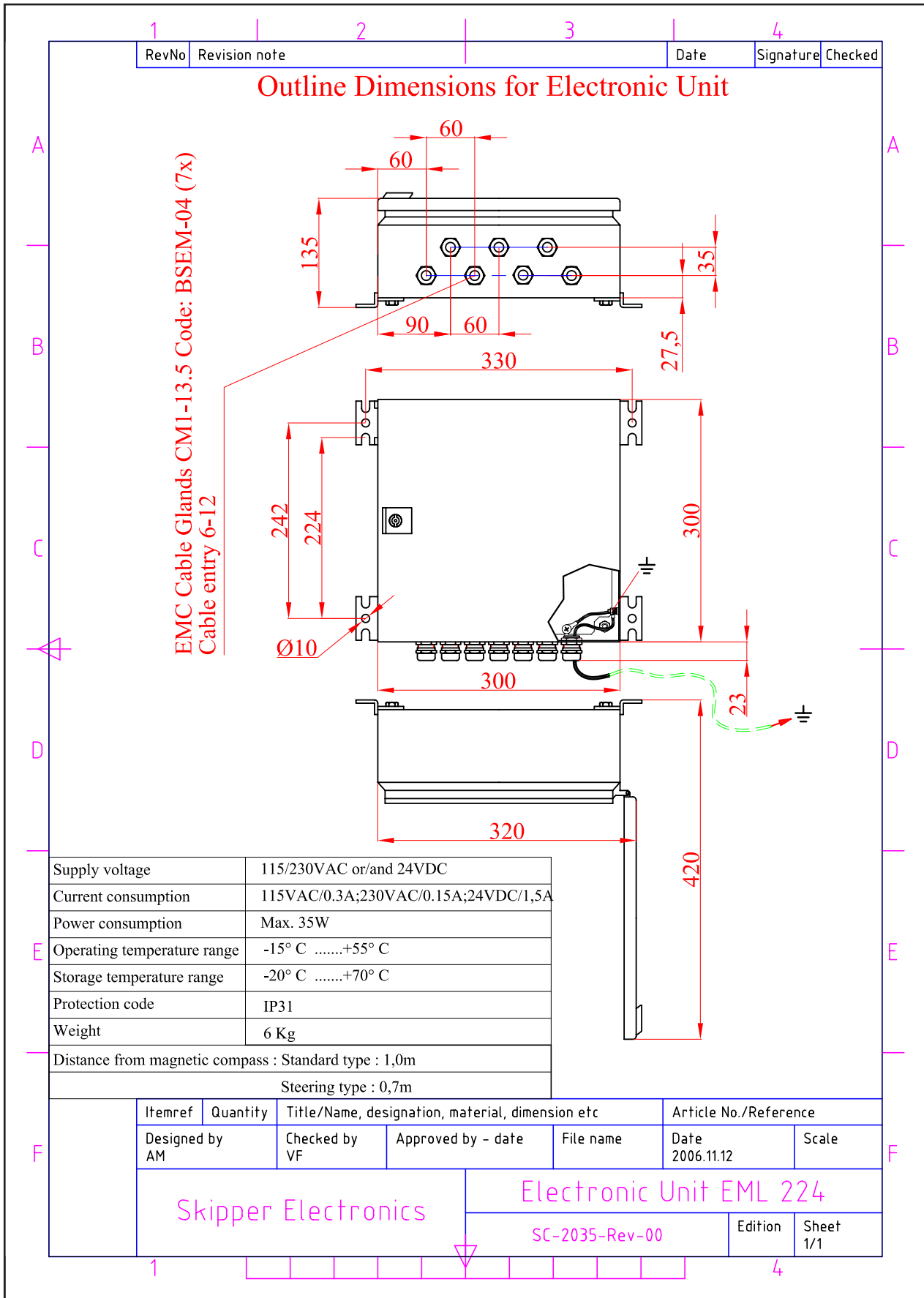

Fig. 11.4 Outline dimensions Electronic Unit